



# HP 8590A Portable RF Spectrum Analyzer Installation Manual

## Serial Numbers

This manual applies directly to analyzers with serial numbers prefixed 2618A and 2618U

For additional important information about serial numbers, see "Analyzers Covered By This Manual" in Chapter 1

Manual Part Number: 08590-90003  
Microfiche Part Number: 08590-90004  
Printed in U.S.A., January, 1987

Copyright © 1986 by Hewlett-Packard Company  
1212 Valleyhouse Drive, Rohnert Park, CA 94928-4999

---

# HP 8590A Documentation Description

## Manuals shipped with your analyzer:

### Installation Manual\*

HP Part Number 08590-90003

- Tells you how to install the spectrum analyzer
- Tells you what to do in case of a failure

*You are here!*

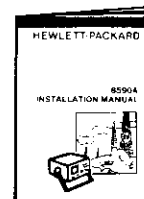

### Operating Manual\*

HP Part Number 08590-90005

- Tells you how to make measurements with your spectrum analyzer
- Describes analyzer features



## Options:

### Support Manual (part of Option 915)\*\*

HP Part Number 08590-90008

- Describes troubleshooting and repair of the analyzer

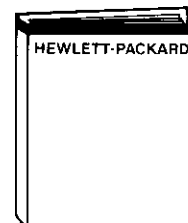

### Programming Manuals

HP Part Numbers:

HP-IB 08590-90011 (Option 021)  
HP-IL 08590-90013 (Option 022)  
RS-232 08590-90015 (Option 023)

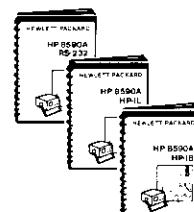

- Describes analyzer operation via a remote controller (computer)

\*Additional copies of the Operating Manual and the Installation Manual are not available separately; together, they constitute the HP 8590A Documentation Package and must be ordered by its HP Part Number—08590-90001.

\*\*Option 915, Service Documentation, consists of one copy each of the Support Manual, the Installation Manual, and the Operating Manual

---

## How to Use This Manual

### Where To Start

If you have just received the **HP 8590A** and want to get it ready to use for the first time:

Skim Chapter 1, "Introducing the HP 8590A," for a brief introduction to the unit and its capabilities.

Thoroughly read Chapter 2, "Preparation for Use," and follow its instructions for:

- unpacking the unit
- preparing it for use
- performing initial calibration routines and a confidence test to get a quick indication that the unit is ready for operation (these are automatic self-checks and require no test equipment).

If you need to verify the unit is operating within its specifications, perform the Operation Verification tests in Chapter 3, "Verifying Specified Operation."

Then use the Operating Manual (HP Part Number 08590-90005) to learn how to use the HP 8590A.

**If the HP 8590A has been in use** and you want to verify that it is operating correctly or to solve an apparent problem:

Perform the calibration routines and confidence test procedure given in Chapter 2, "Preparation for Use," for a quick indication of proper operation.

If you have the necessary test equipment, perform the Operation Verification tests in Chapter 3, "Verifying Specified Operation," to verify that the unit is operating within its specifications.

If there is an apparent problem, read Chapter 4, "If Something Goes Wrong . . .," for hints on what may be wrong and how to solve the problem, and instructions for calling HP for additional help.

---

## Manual Terms and Conventions

Words in this manual that appear in brackets [ ] refer to softkeys that appear on the screen. Keys that appear on the front panel of the instrument appear boxed.

## Printing History

Each new edition of this manual incorporates all material updated since the previous edition. Manual change sheets may be issued between editions, allowing you to correct or insert information in the current edition.

The part number of this manual changes only when a new edition is published. Minor corrections or additions may be made as the manual is reprinted between editions.

Part Number 08590-90003  
First Printing: August 1986  
Second Printing: October 1986  
Third Printing: December 1986  
Fourth Printing: January 1987

---

## Table of Contents

HP 8590A Documentation Description .....	2
How to Use This Manual .....	3
Where to Start .....	3
Manual Terms and Conventions .....	4
Printing History .....	4
 Safety Symbols .....	7
General Safety Considerations .....	8
Electrostatic Discharge .....	9
Reducing Damage Caused by ESD .....	10
Static-Safe Accessories .....	10

### 1 Introducing the HP 8590A

#### Introduction

What You'll Find in This Chapter .....	1-1
Introducing the HP 8590A .....	1-1
Options and Accessories Available .....	1-1
Options .....	1-1
Accessories .....	1-3
Analyzers Covered By This Manual .....	1-5
Serial Numbers .....	1-5
Specifications and Characteristics .....	1-6
Specifications .....	1-6
Characteristics .....	1-11

### 2 Preparation for Use

#### Preparation

What You'll Find in This Chapter .....	2-1
Getting Ready .....	2-1
Initial Inspection .....	2-1
Preparing the HP 8590A for Use .....	2-3
Power Requirements .....	2-3
Setting the Line Voltage Selector Switch .....	2-4
Checking the Fuse .....	2-5
Power Cable .....	2-6
Turning the HP 8590A On for the First Time .....	2-8

---

### 3 Verifying Specified Operation

Verification

What You'll Find in This Chapter .....	3-1
What is Operation Verification? .....	3-1
Before You Start Operation Verification .....	3-2
Test Equipment You'll Need .....	3-2
Accessories You Should Have .....	3-2
Recording the Test Results .....	3-2
If the Analyzer Doesn't Meet Specifications .....	3-3
Periodically Verifying Operation .....	3-3
Frequency Readout Accuracy .....	3-6
Displayed Average Noise .....	3-8
Frequency Response Flatness .....	3-10
Calibrator Amplitude and Frequency Accuracy .....	3-14
Frequency Span Readout Accuracy .....	3-16

### 4 If Something Goes Wrong ...

Problems?

What You'll Find in This Chapter .....	4-1
Before You Call HP .....	4-2
Check the Basics .....	4-2
Read the Warranty .....	4-3
Service Options .....	4-3
How to Call HP .....	4-3
How to Return Your Analyzer for Service .....	4-6
Service Tag .....	4-6
Original Packaging .....	4-6
Other Packaging .....	4-7

#### Appendix A

HP 8590A Messages .....	A-1
-------------------------	-----

#### Appendix B

Service Requests .....	B-1
------------------------	-----

Index .....	Index-1
-------------	---------

---

## Safety Symbols

The following safety symbols are used throughout this manual and in the instrument. Familiarize yourself with each of the symbols and its meaning before operating this instrument.



Instruction manual symbol. The instrument will be marked with this symbol when it is necessary for the user to refer to the instruction manual in order to protect the instrument against damage. Location of pertinent information within the manual is indicated by use of this symbol in the table of contents.



Indicates dangerous voltages are present. Be extremely careful.

**CAUTION** The CAUTION symbol denotes a hazard. It calls attention to a procedure which, if not correctly performed or adhered to, could result in damage to or destruction of the instrument. Do not proceed beyond a CAUTION symbol until the indicated conditions are fully understood and met.

**WARNING** The WARNING symbol denotes a hazard. It calls attention to a procedure which, if not correctly performed or adhered to, could result in injury or loss of life. Do not proceed beyond a WARNING symbol until the indicated conditions are fully understood and met.

---

## General Safety Considerations

### WARNING

BEFORE THIS INSTRUMENT IS SWITCHED ON, make sure it has been properly grounded through the protective conductor of the ac power cable to a socket outlet provided with protective earth contact. Any interruption of the protective (grounding) conductor, inside or outside the instrument, or disconnection of the protective earth terminal can result in personal injury.

### WARNING

There are voltages at many points in the instrument which can, if contacted, cause personal injury. Be extremely careful. Any adjustments or service procedures that require operation of the instrument with protective covers removed should be performed only by trained service personnel.

### CAUTION

BEFORE THIS INSTRUMENT IS SWITCHED ON, make sure its primary power circuitry has been adapted to the voltage of the ac power source. Failure to set the ac power input to the correct voltage could cause damage to the instrument when the ac power cable is plugged in.



---

## Electrostatic Discharge

Electrostatic discharge (ESD) can damage or destroy electronic components. Therefore, all work performed on assemblies consisting of electronic components should be done at a static-free work station.

Figure 1 is an example of a static-safe work station using two types of ESD protection:

- conductive table mat and wrist-strap combination
- conductive floor mat and heel-strap combination

These methods may be used together or separately.

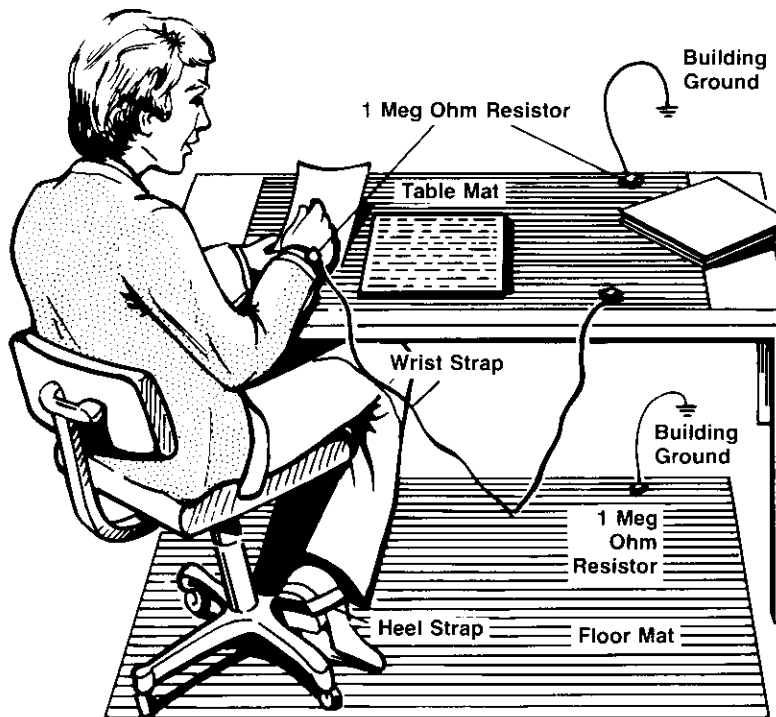

Figure 1. Example of a Static-Safe Work Station

---

## Reducing Damage Caused by ESD

Following are suggestions that may help reduce ESD damage that occurs during testing and servicing operations.

- Before connecting any coaxial cable to an analyzer connector for the first time each day, momentarily ground the center and outer conductors of the cable.
- Personnel should be grounded with a resistor-isolated wrist strap before touching the center pin of any connector and before removing any assembly from the unit.
- Be sure that all instruments are properly earth-grounded to prevent a buildup of static charge.

## Static-Safe Accessories

Table 1 lists static-safe accessories that can be obtained from Hewlett-Packard by using the HP part numbers shown.

*Table 1. Static-Safe Accessories*

HP Part Number	Description
<b>Note:</b> The following items can be ordered through any Hewlett-Packard Sales and Service office	
9300-0797	3M static control mat, 0.6m x 1.2m (2 ft x 4 ft) 4.6m (15 ft) ground wire wrist strap and attachment cord
9300-0980	Wrist strap cord, 1.5m (5 ft)
9300-0985	Wrist strap (large)
9300-0986	Wrist strap (small)
9300-1169	ESD heel strap (reusable 6 to 12 months)
9300-0793	Shoe ground strap (one-time use only)

Table 1. Static-Safe Accessories (continued)

HP Part Number	Description
<p><b>Note:</b> The following ESD accessories can be ordered only from:  Hewlett-Packard Company  Computer Supplies Operation  1320 Kifer Road  Sunnyvale, CA 94086  Phone: (408) 738-8858</p>	
92175A	Black, hard-surface, static control mat, 1.2m x 1.5m (4 ft x 5 ft)
92175B	Brown, soft-surface, static control mat, 2.4 m x 1.2 m (8 ft x 4 ft)
92175C	Small, black, hard-surface, static control mat, 1.2m x 0.9m (4 ft x 3 ft)
92175T	Tabletop static control mat, 58 cm x 76 cm (23 in x 30 in)
92176A	Anti-static carpet, natural color, 1.8m x 1.2m (6 ft x 4 ft)
92176B	Anti-static carpet, natural color, 2.4m x 1.2m (8 ft x 4 ft)
92176C	Anti-static carpet, russet color, 1.8 m x 1.2m (6 ft x 4 ft)
92176D	Anti-static carpet, russet color, 2.4m x 1.2m (8 ft x 4 ft)

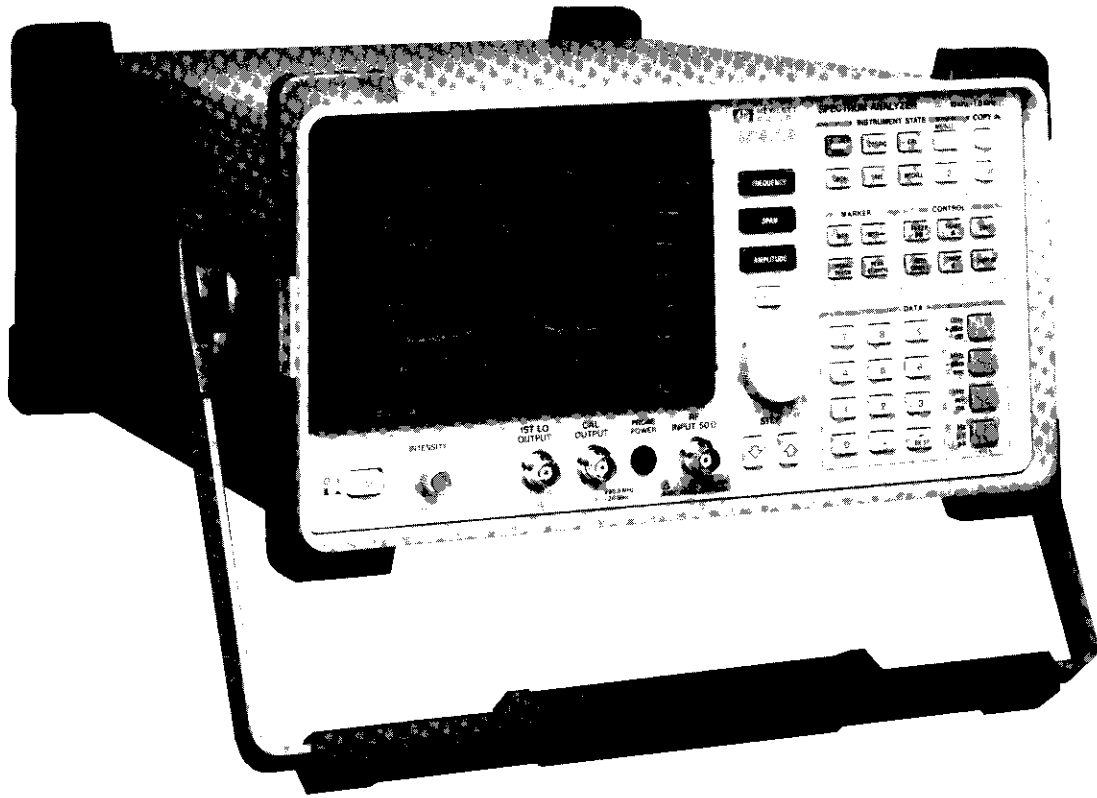

Figure 1-1. The HP 8590A Spectrum Analyzer

---

# INTRODUCING THE HP 8590A

---

## What You'll Find in This Chapter

This chapter introduces you to the HP 8590A Spectrum Analyzer and its options and accessories that tailor the unit to your specific needs. To acquaint you with the analyzer's full capabilities, the HP 8590A specifications and characteristics are also provided.

## Introducing the HP 8590A

The HP 8590A Spectrum Analyzer is a small, lightweight test instrument that combines a wide frequency range (10 kHz to 1.5 GHz) and amplitude range ( $-115$  dBm to  $+30$  dBm) with over 100 easy-to-use functions to handle just about any RF signal measurement. Its portability and easy, highly automatic operation make it ideal for service and troubleshooting use in R&D labs and in manufacturing and service environments in the CATV, mobile radio, and related communications businesses.

The HP 8590A is a complete, self-contained instrument that needs only an external ac power source for operation. An ac power cable, suitable for use in the country to which the analyzer is originally shipped, is included with the unit.

## Options and Accessories Available

### Options

Many options are available to tailor the HP 8590A to your needs. Options can be ordered by option number when you order the analyzer. Some of the options are also available as kits that can be ordered and installed after you have received your HP 8590A.

**75-Ohm Input Impedance (Option 001):** This option provides a 75-ohm input impedance instead of the standard 50-ohm impedance. Analyzers with this option use different IF and RF circuit boards and a different front panel from the standard units.

---

**HP-IB (Option 021):** Option 021 enables you to control your HP 8590A from a computer that uses an HP-IB interface bus. Such computers include the HP 200 and HP 300 series and the HP Vectra. The option also enables the HP 8590A to control a printer or plotter. Option 021 includes an HP-IB connector on the rear panel and an HP-IB Programming Manual.

Option 021 is also available as a kit (HP Part Number 08590-60052). The kit includes a printed circuit board, connector, manual, and installation instructions.

**HP-IL (Option 022):** Option 022 enables you to control your HP 8590A from a computer that uses an HP-IL interface bus. Such computers include the HP-71 and the HP-75. The option also enables the HP 8590A to control a printer or plotter. Option 022 includes an HP-IL connector on the rear panel and an HP-IL Programming Manual.

Option 022 is also available as a kit (HP Part Number 08590-60053). The kit includes a printed circuit board, connector, manual, and installation instructions.

**RS-232 (Option 023):** Option 023 enables you to control your HP 8590A from a computer that uses an RS-232 interface bus. Such computers include the HP Vectra, the IBM PC, XT, and AT, and compatibles. The option also enables the HP 8590A to control a printer or plotter. Option 023 includes an RS-232 connector on the rear panel and an RS-232 Programming Manual.

Option 023 is also available as a kit (HP Part Number 08590-60054). The kit includes a printed circuit board, connector, manual, and installation instructions.

**Front-Panel Cover (Option 040):** The front-panel cover snaps onto the front of your HP 8590A to protect the front panel during travel and when the unit is not in use. The cover has a recessed area in which you can store the HP 8590A Operating Manual, a programming manual, or an HP-71 Handheld Computer.

Option 040 is also available as a kit (Impact Cover Assembly, Deep; HP Part Number 5062-0792).

**Rack Mount Flange Kit (Option 908):** This option provides the parts necessary to mount the HP 8590A in an HP System II cabinet or in a standard 19-inch (482.6-mm) equipment rack.

Option 908 is also available as a kit (HP Part Number 5062-0800).

**1.79-GHz Extended Frequency (Option H18):** Option H18 extends the upper limit of the frequency range over which the HP 8590A is specified from 1.5 GHz to 1.79 GHz.

---

**Rack Mount Flange Kit With Handles (Option 909):** Option 909 is the same as option 908 but includes front handles for added convenience.

Option 909 is also available as a kit (HP Part Number 5062-1900).

**Operating and Installation Manuals (Option 910):** An additional copy of the HP 8590A Operating Manual and the Installation Manual are available as a set under Option 910. This set is called the Documentation Package, and has HP Part Number 08590-90001.

**Service Documentation (Option 915):** Option 915 includes one copy of the HP 8590A Operating Manual, the Installation Manual, and the Support Manual. This set is called the Support Package and has HP Part Number 08590-90007.

## Accessories

A number of accessories are available from Hewlett-Packard to help you configure your HP 8590A for your specific needs.

**AC Probe:** The HP 8590A has a front-panel PROBE POWER connector for the use of high-impedance active probes such as the HP 1120A. High-impedance probes permit you to test high-frequency circuits without significant loading effects.

### CAUTION

Do not use dc-coupled probes; they may cause damage to the spectrum analyzer input circuit.

**Broadband Preamplifier:** The HP 10855A Preamp provides a minimum of 22 dB gain from 2 MHz to 1300 MHz to enhance measurements of very low-level signals. It operates conveniently from the PROBE POWER output of the HP 8590A.

**Close Field Probe:** The HP 11940A Close-Field Probe is a small, hand-held, electromagnetic-field sensor. The probe provides repeatable, absolute, magnetic-field measurements from 30 MHz to 1 GHz. When attached to a source, the probe generates a localized magnetic field for electromagnetic interference (EMI) susceptibility testing.

**Computer:** The HP-71 Handheld Computer is a powerful, readily portable computational tool well suited to test instrument control. It uses a powerful BASIC language that allows structured programming techniques. It can be used to control the HP 8590A through the HP-IL interface (Option 022 for the HP 8590A).

---

**Monitor:** The HP 82913A is a 12-inch monitor that provides a larger display for the HP 8590A in fixed installations.

**Plotter:** The HP ColorPro 7440A Graphics Plotter adds a color printout capability to the HP 8590A for permanent records of important measurements. The eight-pen HP ColorPro produces color plots with 0.025-mm (0.001-in.) resolution on either 8.5 x 11-inch paper or transparency film. The plotter can be ordered with HP-IB or RS-232 interfaces to correspond to the interface option installed on the HP 8590A.

**Printer:** The HP 2225A ThinkJet Personal Printer provides fast, quiet, portable printing with graphics capability for another form of permanent records of your test results. The printer can be ordered with HP-IB, HP-IL, or RS-232 interfaces to correspond to the interface option installed on the HP 8590A.

**Rack Slide Kit:** This kit (HP Part Number 1494-0060) provides the hardware to adapt Rack Mount Kits (Options 908 and 909) for mounting the analyzer on slides in an HP System II cabinet.

**RF Limiter:** The HP 11867A Limiter protects the analyzer input circuits from damage due to high power levels. It operates over a frequency range of dc to 1800 MHz and begins reflecting signal levels over 1 milliwatt up to 10 watts average power and 100 watts peak power.

**Tracking Generator:** The HP 8444A Option 59 Tracking Generator provides a leveled, calibrated signal output with a frequency equal to the tuned frequency of the HP 8590A. This lets you make swept frequency tests such as insertion loss and return loss at frequencies up to 1500 MHz.

**Transit Case:** The transit case (HP Part Number 9211-5604) provides extra protection for your HP 8590A for frequent travel situations. The HP transit case protects your instrument from hostile environments, shock, vibration, moisture, and impact while providing a secure enclosure for shipping.

**50-ohm/75-ohm Minimum-Loss Pad:** The HP 11852A is a low VSWR minimum-loss pad that is required for measurements on 75-ohm devices.

**75-ohm Matching Transformer:** The HP 11694A allows you to make measurements in 75-ohm systems while retaining amplitude calibration. It is effective over a frequency range of 3 to 500 MHz.



---

## Analyzers Covered By This Manual

This manual applies to analyzers with the serial number prefixes listed under SERIAL NUMBERS on the title page.

### Serial Numbers

Hewlett-Packard makes frequent improvements to its products to enhance their performance, usability, or reliability, and to control costs. HP service personnel have access to complete records of design changes to each type of equipment, based on the equipment's serial number. Whenever you contact HP about your analyzer, have the complete serial number available to ensure obtaining the most complete and accurate information possible.

A mylar serial number label is attached to the rear of the analyzer. The serial number has two parts: the prefix (the first four numbers and a letter), and the suffix (the last five numbers). See Figure 1-2.

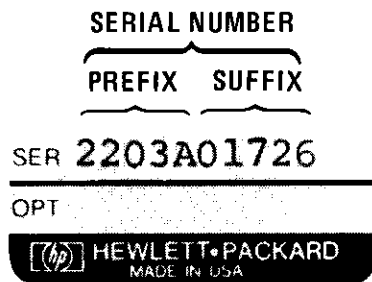

Figure 1-2. Typical Serial Number Label

The first four numbers of the prefix are a code that identifies the date of the last major design change that is incorporated in your analyzer. The letter identifies the country in which the unit was manufactured. The five-digit suffix is a sequential number and is different for each unit. Whenever you list the serial number or refer to it in obtaining information about your analyzer, be sure to use the complete number, including the full prefix and the suffix.

## Specifications and Characteristics

Specifications describe the warranted analyzer performance over the temperature range of 0° to +55°C, unless stated otherwise. All specifications apply after the unit has reached a stable operating temperature as defined by the Temperature Stability Specification, and when functions are coupled (**Auto Couple** key), and after calibration routines have been run, if required.

Characteristics provide useful information in the form of typical, nominal, or approximate values for analyzer performance.

### Specifications

The HP 8590A specifications are listed in Table 1-1.

Table 1-1. HP 8590A Specifications

<b>General Specifications</b>
<p><b>Temperature Range</b>            Operating            0 degrees to +55 degrees Celsius            Storage            -40 degrees to +75 degrees Celsius            Temperature Stability            The analyzer will meet its specifications 2 hours after storage at a constant temperature within the operating temperature range and 30 minutes after the analyzer is turned on</p>
<p><b>EMI Compatibility</b>            Conducted and radiated interference is in compliance with CISPR Publication 11 (1985) and Messemppfaenger Postverfuegung 526/527/79 (Kennzeichnung Mit F-Nummer/Funkschutzzeichen)</p>
<p><b>Humidity Range</b>            Type-tested from 50% to 95% relative humidity (<math>\leq +4^{\circ}\text{C}</math>) per requirements of MIL-STD-810C, Method 507.1, Procedure IV</p>
<p><b>Audible Noise</b>            &lt;37.5 dBA pressure and &lt;5.0 Bels power (ISO DP7779)</p>
<p><b>Power Requirements</b>            86 to 127, or 195 to 253 volts rms; 47 to 66 Hz.            Power consumption is less than 120 VA</p>

Table 1-1. HP 8590A Specifications (continued)

<b>Frequency Specifications</b>
<p><b>Frequency Range</b>            10 kHz to 1.5 GHz            1 MHz to 1.5 GHz (Option 001)            10 kHz to 1.79 GHz (Option H18)</p>
<p><b>Frequency Accuracy</b>            Readout Accuracy (Tuning Accuracy)              <math>\pm(5 \text{ MHz} + 1\% \text{ of frequency span})</math>, from 10 kHz to 1.5 GHz              <math>\pm(5 \text{ MHz} + 1\% \text{ of frequency span})</math>, from 10 kHz to 1.79 GHz (Option H18)            Resolution            4 digits</p>
<p><b>Frequency Spans</b>            Full Span            50 kHz to 1.5 GHz with 4-digit resolution            Zero Span            Analyzer functions as a manually tuned receiver, at the frequency indicated by the CENTER FREQUENCY readout, for time domain display of signal modulation            Frequency Span Readout Accuracy  <math>&lt;\pm 3\%</math> of indicated frequency span</p>
<p><b>Frequency Sweep</b>            Automatic (AUTO)            Sweep times from 20 milliseconds to 100 seconds, adjusted automatically to maintain absolute amplitude calibration for any combination of frequency span, resolution bandwidth, and video filter bandwidth</p>
<p>Readout Accuracy  <math>&lt;\pm 10\%</math> of indicated sweep time setting</p>
<p><b>Resolution and Stability</b>            Drift  <math>&lt;50 \text{ kHz/5 minutes}</math> after 2-hour warmup and 5 minutes after setting center frequency            Noise Sidebands  <math>&lt;-65 \text{ dB down and } &gt;30 \text{ kHz offset}</math> from CW signal with 1-kHz resolution bandwidth and 30-Hz video bandwidth</p>

Table 1-1. HP 8590A Specifications (continued)

<b>Amplitude Specifications</b>
<p><b>Amplitude Range</b></p> <p>1 MHz to 1.3 GHz</p> <ul style="list-style-type: none"> <li>-115 dBm to +30 dBm for 50-ohm calibration</li> <li>-63 dBmV to +77 dBmV for 75-ohm calibration (Option 001)</li> </ul> <p>300 kHz to 1.5 GHz</p> <ul style="list-style-type: none"> <li>-113 dBm to +30 dBm for 50-ohm calibration</li> <li>-61 dBmV to +77 dBmV for 75-ohm calibration (Option 001)</li> </ul> <p>1.5 GHz to 1.79 GHz (Option H18)</p> <ul style="list-style-type: none"> <li>-95 dBm to +30 dBm for 50-ohm calibration</li> </ul> <p>Maximum Input (Damage) Levels</p> <ul style="list-style-type: none"> <li>+30 dBm (1 watt, 7.1 Vrms), 0 volt dc</li> </ul> <p>Displayed Average Noise Level</p> <ul style="list-style-type: none"> <li>&lt;-115 dBm for frequencies &gt;1 MHz to 1.3 GHz</li> <li>&lt;-113 dBm for frequencies &gt;300 kHz to 1.5 GHz</li> <li>&lt;-63 dBmV for frequencies &gt;1 MHz to 1.3 GHz (Option 001)</li> <li>&lt;-61 dBmV for frequencies &gt;300 kHz to 1.5 GHz (Option 001)</li> <li>&lt;-95 dBm for frequencies &gt;1.5 GHz to 1.79 GHz (Option H18)</li> </ul> <p>The displayed average noise level determines sensitivity (minimum discernible signal). Signals at this input level peak approximately 3 dB above the displayed noise level. Maximum average noise level with 0-dB input attenuation, 1-kHz resolution bandwidth, and 30-Hz video bandwidth.</p> <p>Calibrated Display Range</p> <ul style="list-style-type: none"> <li>Log; from reference level <ul style="list-style-type: none"> <li>70 dB with 10 dB/div amplitude scale</li> <li>1 to 20 dB/div amplitude scales in 1-dB steps</li> </ul> </li> <li>Linear <ul style="list-style-type: none"> <li>8 divisions with LINEAR amplitude scale</li> </ul> </li> </ul> <p>Maximum Dynamic Range</p> <ul style="list-style-type: none"> <li>70 dB for on-screen viewing</li> <li>70 dB for signal-to-distortion</li> <li>95 dB for IF-compression-to-noise</li> </ul> <p>Readout Resolution (with markers)</p> <ul style="list-style-type: none"> <li>&lt;0.05 dB for log scales</li> <li>&lt;0.05% of reference level for linear scales</li> </ul> <p>Units in dBm, dBmV, dB<math>\mu</math>V, volts, and watts</p>

Table 1-1. HP 8590A Specifications (continued)

<b>Amplitude Specifications (continued)</b>	
<b>Amplitude Accuracy</b>	With AUTO selected, amplitude accuracy is determined by one or more of the following factors and the signal-to-noise ratio.
<b>Calibrator Output (CAL OUTPUT)</b>	299.9 MHz $\pm$ 300 kHz
	-20 dBm $\pm$ 1 dB level, 50-ohm calibration
	+27 dBmV $\pm$ 1 dB level, 75-ohm calibration (Option 001)
<b>Reference Level</b>	10-dB steps for calibrated reference level adjustment from -139 dBm to +50 dBm
<b>Reference Level Step Accuracy at Calibration Frequency (in corrected mode)</b>	<b>Note:</b> Before trying to verify these reference-level step accuracies, you must run the Amplitude Calibration (AMPTD CAL) routine.
	< $\pm$ 1.75 dB for +30 to -120 dBm range (0 to 60-dB attenuation)
	< $\pm$ 1.25 dB for 0 to -120 dBm range (10-dB attenuation) at any fixed frequency
	< $\pm$ 0.5 dB for 0 to -59 dBm range (10-dB attenuation) at any fixed frequency
<b>Frequency Response</b>	
<b>10 kHz to 1.5 GHz</b>	< $\pm$ 1.5 dB with 10-dB input attenuation referenced to the CAL OUTPUT signal
	< $\pm$ 1.0 dB referenced to mid-point between highest and lowest peak excursions
<b>1.5 to 1.79 GHz (Option H18)</b>	< $\pm$ 3 dB with 10-dB input attenuation referenced to CAL OUTPUT signal
	< $\pm$ 2 dB referenced to mid-point between highest and lowest peak excursions
	<b>Note:</b> Frequency response may include input attenuator and mixer flatness
<b>Input Attenuator</b>	0 dB to 60 dB of input attenuation, selectable in 10-dB steps
<b>Input Attenuator Step Accuracy at Calibration Frequency</b>	< $\pm$ 0.5 dB over 60-dB range
<b>Resolution Bandwidth Switching (Amplitude Variation)</b>	< $\pm$ 0.25 dB for 3 kHz to 3 MHz range

Table 1-1. HP 8590A Specifications (continued)

<b>Amplitude Specifications (continued)</b>
<b>Amplitude Accuracy (continued)</b>
Display Scale Fidelity CRT linearity and log fidelity affect amplitude accuracy at levels other than reference level
Log Incremental Accuracy < $\pm 0.1$ dB/dB change over 70 dB-range
Log Maximum Cumulative Error $\pm 0.75$ dB maximum over $-60$ -dB range from reference level $\pm 1.0$ dB maximum over $-70$ -dB range from reference level
Linear Accuracy < $\pm 3\%$ of reference level setting
Gain Compression RF Input < 1 dB for $-10$ dBm total power at input mixer Internal IF < 1 dB when signals are higher than reference level and total power at input mixer is $-20$ dBm
<b>Spurious Responses</b>
Second Harmonic Distortion (for $-45$ dBm total power at mixer) < $-70$ dBc for frequencies $> 5$ MHz < $-60$ dBc for frequencies $\leq 5$ MHz
Third Order Intermodulation Distortion < $-70$ dBc for input signals greater than 5 MHz (input signals must be $-30$ dBm at the input mixer and greater than 50 kHz apart)
Residual Responses < $-95$ dBm with 0-dB input attenuation and no signal present at input (except 1728 MHz, which is $< -88$ dBm; Option H18)

## Characteristics

The HP 8590A characteristics are listed in Table 1-2.

Table 1-2. HP 8590A Characteristics

<b>Spectral Resolution and Stability</b>
<p><b>Resolution Bandwidths</b>            1 kHz to 3 MHz, eight selectable resolution bandwidths in 1,3,10 sequence. Bandwidth shape is approximately Gaussian (synchronously tuned, 4-pole filter). Bandwidth may be selected independently or coupled for optimum ratio of frequency span to resolution bandwidth.</p> <p><b>Video Bandwidths</b>            30 Hz to 3 MHz in 1,3,10 sequence. Post-detection low-pass filter averages displayed noise for a smooth trace. Video bandwidth may be selected independently or coupled for optimum ratio of frequency span to resolution and video bandwidth.</p> <p><b>Signal Track</b>            Signal is held at display center, compensates for drift.</p>
<b>Sweep Trigger</b>
<p><b>Free Run</b>            End of each sweep triggers new sweep.</p> <p><b>Line</b>            Sweep triggered at ac line (main) frequency.</p> <p><b>Video</b>            Sweep triggered on post-detection video waveform. Trigger level can be set by display line when video trigger is selected.</p> <p><b>Single</b>            Single sweep started or reset by pressing <input type="button" value="TRIG"/>, [SINGLE SWEEP].</p> <p><b>External</b>            BNC input (rear panel), TTL levels, positive edge triggers sweep.</p>

Table 1-2. HP 8590A Characteristics (continued)

<b>Amplitude Accuracy</b>
<p><b>Log Scale Switching</b> No significant error for 1- to 20-dB/div scale range. Scale switching is a built-in function of the product design.</p>
<b>Front-Panel Inputs/Outputs</b>
<p><b>RF INPUT 50 OHM</b> Input Impedance 50 ohms nominal; 50-ohm BNC female connector. 75 ohms nominal; 75-ohm BNC female connector (Option 001).</p> <p><b>1ST LO OUTPUT</b> 2.05 to 3.55 GHz, +10 dBm nominal, 50-ohm BNC connector. Terminate with a 50-ohm load when not in use.</p> <p><b>CAL OUTPUT</b> -20 dBm at 299.9 MHz, with second through fourth harmonics greater than -60 dBm into 50 ohms. +27 dBmV at 299.9 MHz into 75 ohms (Option 001).</p> <p><b>PROBE POWER</b> +15V, -12.6V, and GND (150 mA maximum) for use with high-impedance probes.</p>
<b>Rear-Panel Inputs/Outputs</b>
<p><b>AUX VIDEO OUTPUT</b> 50-ohm BNC connector, 0 to 1 volt.</p> <p><b>MONITOR OUTPUT</b> 50-ohm BNC connector, NTSC format, 19.2 kHz horizontal sync. (The HP 82913A 12-inch monitor is recommended.)</p> <p><b>HIGH SWEEP IN/OUT</b> BNC connector, TTL high = sweep, TTL low = retrace.</p> <p><b>SWEEP OUTPUT</b> BNC connector, 5k ohm, 0- to +10-volt ramp.</p> <p><b>AUX IF OUTPUT</b> 50-ohm BNC connector, -10 to -60 dBm signal level, 21.4 MHz.</p>



Table 1-2. HP 8590A Characteristics (continued)

**EXTERNAL TRIGGER INPUT**

BNC connector, TTL levels, positive edge triggers sweep.

**Interface Connector**

HP-IB (Option 021), HP-IL (Option 022), or RS-232 (Option 023).

**HP-IB Codes**

SH1, AH1, T6, L4, SR1, RL1, PP0, DC1, DT1, C1, C2, C3, and C28.

**Weight****Net**

13.5 kg (29.8 lbs)

**Shipping**

15.7 kg (34.8 lbs)

**Dimensions**

Legend: inches  
(millimeters)

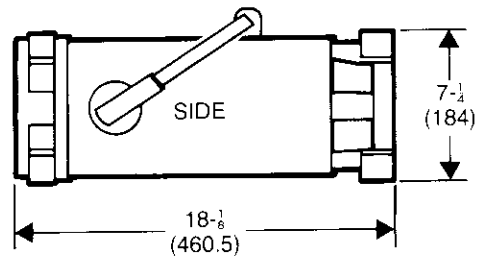
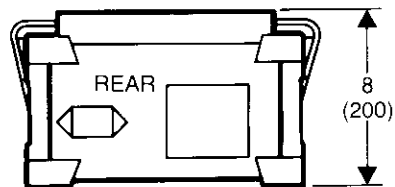
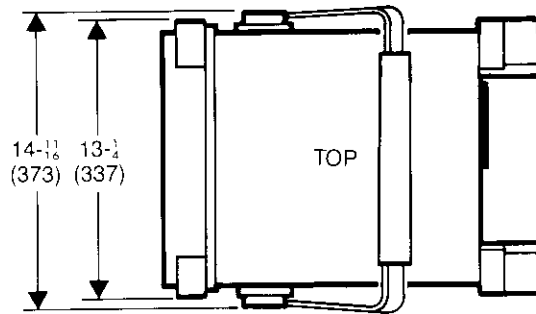



---

# PREPARATION FOR USE

---

## What You'll Find in This Chapter

This chapter describes the process of getting the HP 8590A ready to use. The process includes initial inspection procedures, setting up the unit for the selected ac power source, and performing automatic calibration routines and a confidence test to indicate that the unit is operating correctly.

## Getting Ready

### Initial Inspection

Inspect the shipping container for damage. If the shipping container or cushioning material is damaged, keep it until you have verified that the contents are complete and you have tested the analyzer mechanically and electrically.

The contents of the shipment should be as shown in Figure 2-1 and its accompanying legend. If the contents are incomplete or if the analyzer does not pass the operation verification tests (procedures are provided in Chapter 3), notify the nearest Hewlett-Packard office. If the shipping container is damaged or the cushioning material shows signs of stress, also notify the carrier. Keep the shipping materials for the carrier's inspection. The HP office will arrange for repair or replacement without waiting for a claim settlement.

If the shipping container and cushioning material are in good condition, retain them for possible future use. You may wish to ship the analyzer to another location or to return it to Hewlett-Packard for service. Chapter 4 provides instructions for repackaging and shipping the analyzer.

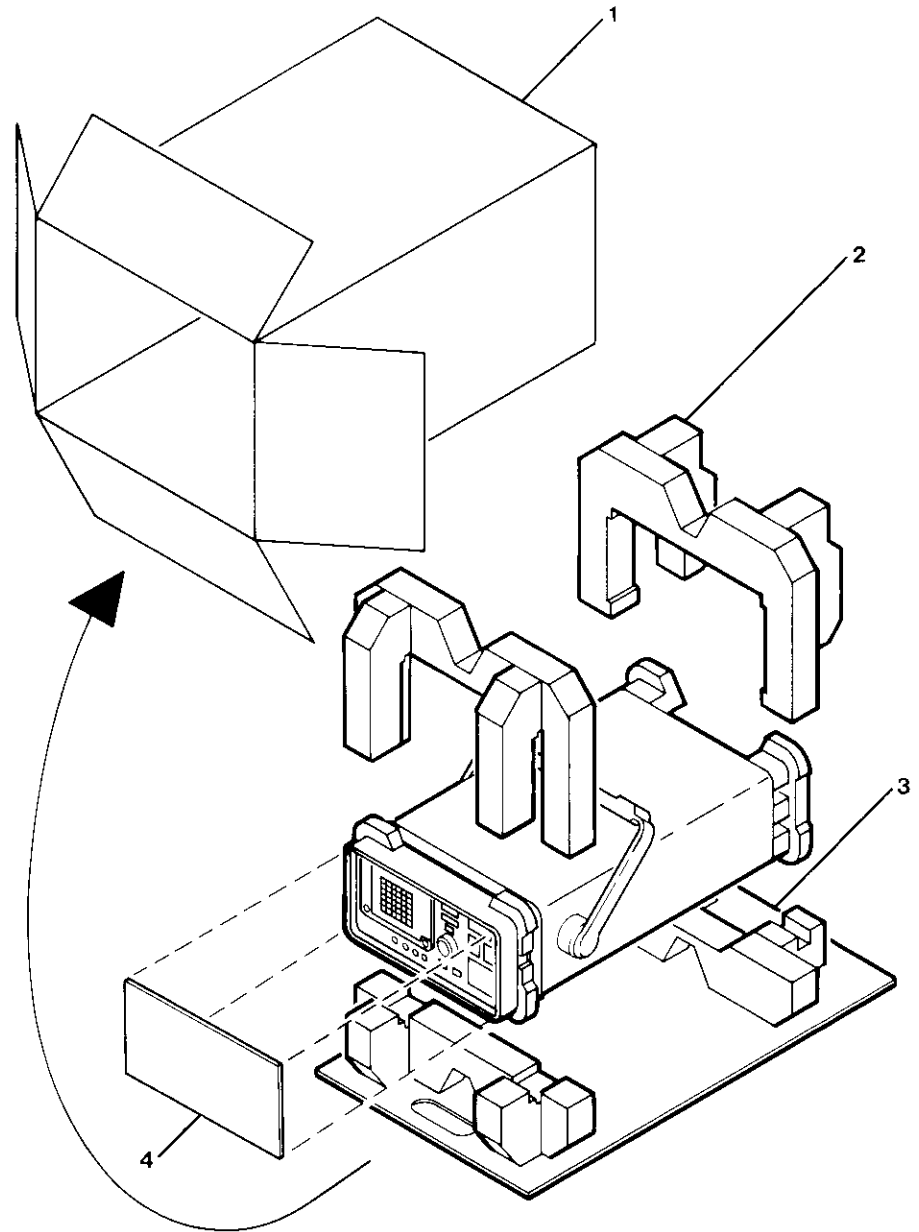

Item	Description	HP Part Number
1	Outer Carton	9211-5636
2	Pads (2)	08590-80013
3	Bottom Tray	08590-80014
4	Front Pad	9220-4488

Figure 2-1. HP 8590A Shipping Container and Contents

---

## Preparing the HP 8590A for Use

The HP 8590A is a portable instrument and requires no physical installation other than connection to a source of ac power.

### CAUTION

DO NOT connect ac power until you have verified that the line voltage is correct, the proper fuse is installed, and the line voltage selector switch is properly positioned, as described in the following paragraphs. Damage to the equipment could result.

**Note:** If you want to install your HP 8590A in an HP System II cabinet or a standard 19-inch (486.2-mm) equipment rack, complete instructions are provided in a Service Note that is included with Options 908 and 909 Rack Mounting Kits.

## Power Requirements

The power requirements for the HP 8590A are listed in Table 2-1.

Table 2-1 Power Requirements

Characteristic	Requirement
Input Voltage	86 to 127, or 195 to 253 volts rms
Frequency	47 to 66 Hz
Power	120 VA max

---

## Setting the Line Voltage Selector Switch

### CAUTION

BEFORE CONNECTING the HP 8590A to the power source, you must set the rear-panel voltage selector switch correctly to adapt the HP 8590A to the power source. An improper selector switch setting can damage the analyzer when it is turned on.

Set the instrument's rear-panel voltage selector switch to the line voltage range (115V or 230V) corresponding to the available ac voltage. See Figure 2-2. Insert a small screwdriver or similar tool in the slot and slide the switch up or down so that the proper voltage label is visible.

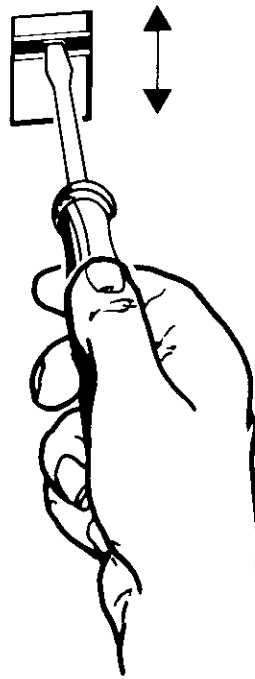

Figure 2-2. Setting the Voltage Selector Switch

---

## Checking the Fuse

**Note:** The ac line input fuse is the same value regardless of the input line voltage. It is a fast-blow fuse, rated at 6.3A, 250V: its HP part number is 2100-0703.

The line fuse is housed in a small container immediately above the rear-panel power connector (see Figure 2-3). The container provides space for storing a spare fuse, as shown in the figure.

To check the fuse, insert the tip of a screwdriver in the slot at the bottom of the container and pry gently to remove the container. If the fuse is defective or missing, install a new fuse in the proper position and reinsert the fuse container.

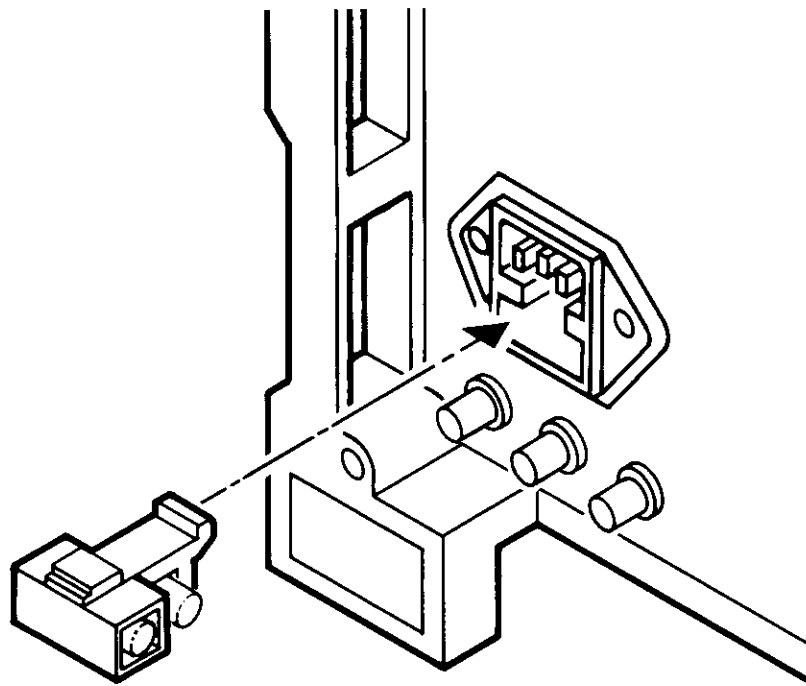

Figure 2-3. Checking the Line Fuse

---

## Power Cable

The HP 8590A is equipped with a three-wire power cable, in accordance with international safety standards. When connected to an appropriate power line outlet, this cable grounds the instrument cabinet.



### WARNING

**Failure to ground the analyzer properly can result in personal injury. Before turning on the HP 8590A, you must connect its protective earth terminals to the protective conductor of the main power cable. Insert the main power cable plug only into a socket outlet that has a protective earth contact. DO NOT defeat the earth-grounding protection by using an extension cable, power cable, or autotransformer without a protective ground conductor. If you are using an autotransformer, make sure its common terminal is connected to the protective earth contact of the power source outlet socket.**

Various power cables are available to connect the HP 8590A to the types of ac power outlets unique to specific geographic areas. The cable appropriate for the area to which the analyzer is originally shipped is included with the unit. You can order additional ac power cables for use in different areas. Table 2-2 lists the available ac power cables, illustrates the plug configurations, and identifies the geographic area in which each cable is appropriate.

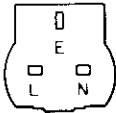
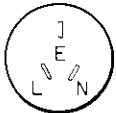
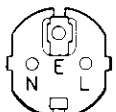

Table 2-2. AC Power Cables Available

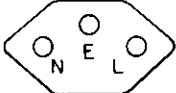
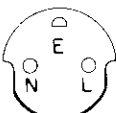
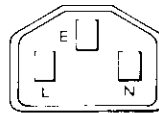
Plug Type**	Cable HP Part Number	Plug Description	Cable Length cm (inches)	Cable Color	For Use In Country
250V 	8120-1351 8120-1703	Straight*BS1363A 90°	229 (90) 229 (90)	Mint Gray Mint Gray	Great Britain, Cyprus, Nigeria, Rhodesia, Singapore, So. Africa, India
250V 	8120-1369 8120-0696	Straight*NZSS198/ASC112 90°	201 (79) 221 (87)	Gray Gray	Australia, New Zealand
250V 	8120-1689 8120-1692	Straight*CEE7-Y11 90°	201 (79) 201 (79)	Mint Gray Mint Gray	East and West Europe, Saudi Arabia, United Arab Republic (unpolarized in many nations)
125V 	8120-1348 8120-1398 8120-1754	Straight*NEMA5-15P 90° Straight*NEMA5-15P	203 (80) 203 (80) 91 (36)	Black Black Black	United States Canada, Japan (100 or 200V), Mexico, Phillipines, Taiwan
	8120-1378 8120-1521 8120-1676	Straight*NEMA5-15P 90° Straight*NEMA5-15P	203 (80) 203 (80) 91 (36)	Jade Gray Jade Gray Jade Gray	
250V 	8120-2104	Straight*SEV1011 1959-24507 Type 12	201 (79)	Gray	Switzerland
220V 	8120-0698	Straight*NEMA6-15P			
250V 	8120-1860	Straight*CEEE22-VI			
<p>* Part number shown for plug is industry identifier for plug only. Number shown for cable is HP Part Number for complete cable, including plug.</p> <p>** E = Earth Ground; L = Line; N = Neutral.</p>					

---

## Turning the HP 8590A On for the First Time

When you turn the analyzer on for the first time, you should perform frequency and amplitude calibration routines to calibrate the unit and a confidence test that indicates that the unit generally is functioning correctly. These are automatic self-tests that are completed in less than 15 minutes and require no external test equipment.

Perform the following steps:

1. Press **LINE**.

After a few seconds, the screen displays the analyzer's model number (HP 8590A), and the firmware date (for example, 10.9.86 indicates September 10, 1986).

**Note:** Record the firmware date and keep it for reference. If you should ever need to call HP for service or with any questions regarding your analyzer, it will be helpful to have the firmware date readily available.

If your analyzer is equipped with Option 021 (HP-IB interface) or Option 022 (HP-IL interface), the appropriate interface address (HP-IB ADRS: XX or HP-IL ADRS: XX) also appears on the screen. If your analyzer is equipped with Option 023 (RS-232 interface), the baud rate (RS232: XXXX) is displayed.

2. Allow the analyzer to warm up in accordance with the Temperature Stability specification in Table 1-1.
3. Connect a 50-ohm coaxial cable (such as HP 10503A) between the front-panel CAL OUTPUT and RF INPUT connectors.
4. Perform the frequency calibration routine by pressing **CAL** and [CAL FREQ].

During the routine, CAL: SWEEP, CAL: FREQ, CAL: SPAN, and CAL: SWEEP DELAY are displayed as the sequence progresses. CAL: DONE appears when the routine is completed. Any failures or discrepancies produce a message on the screen; see Appendix A for descriptions of the HP 8590A messages.

5. Perform the amplitude calibration routine by pressing [CAL AMPTD].

During the routine, CAL; AMPTD, CAL: 3 dB BW, CAL: ATTEN, and CAL: LOGAMP are displayed as the sequence progresses. CAL: DONE appears when the routine is completed. Any failures or discrepancies produce a message on the screen; see Appendix A.

- 
6. When the frequency and amplitude calibration routines have been completed successfully, store the data by pressing [CAL STORE].

The calibration routines calibrate the analyzer by generating correction factors. [CAL STORE] stores the calibration correction factors in non-volatile memory: the analyzer will automatically apply these factors in future measurements.

7. Perform a confidence test by pressing [CAL], [MORE], [CONF TEST].

The analyzer performs a self test by cycling through its major functions. The test is performed within one to two minutes. If the unit does not function properly, a message appears on the screen: see Appendix A.

When the calibration routines and the confidence test have been completed successfully, the analyzer is ready for normal operation.



---

# VERIFYING SPECIFIED OPERATION

---

## What You'll Find in This Chapter

This chapter contains five test procedures which test the electrical performance of the HP 8590A Spectrum Analyzer. Collectively, these tests are called Operation Verification.

## What is Operation Verification?

Operation Verification verifies that performance is within the most critical specifications of Table 1-1. The following tests are included in Operation Verification:

- Frequency Readout Accuracy
- Displayed Average Noise
- Frequency Response Flatness
- Calibrator Amplitude And Frequency Accuracy
- Frequency Span Readout Accuracy

Operation Verification takes less than one hour. You can use Operation Verification as a quick incoming inspection test or as a partial calibration test. If the analyzer passes Operation Verification, there is an 80% confidence level that it meets all its specifications.

An even quicker test of the spectrum analyzer's basic ability to function is called the Confidence Test. This test is described in the "Turning the HP 8590A On for the First Time" section in Chapter 2.

The highest level test, called a Performance Verification test, is an in-depth test that verifies that performance is within all specifications of Table 1-1. This test is time consuming and requires extensive test equipment. It is documented in the HP 8590A Support Manual; see "Service Documentation (Option 915)" in Chapter 1 for ordering information.

None of the test procedures described above involve removing the cover of the spectrum analyzer.

---

## Before You Start Operation Verification

There are four things you must do **before** starting Operation Verification:

1. Switch the analyzer on and let it warm up in accordance with the Temperature Stability specification in Table 1-1.
2. Read Chapter 1 of the Operating Manual, "Making Your First Measurement."
3. After the analyzer has warmed up as specified, perform the Calibration Procedure documented in "Making Your First Measurement." The performance of the analyzer is only specified after the analyzer calibration routines have been run and if the analyzer is auto-coupled.
4. Read the rest of this section before you start any of the tests, and make a copy of the Operation Verification Test Record described below.

### Test Equipment You'll Need

Table 3-1 lists the recommended test equipment for Operation Verification. Any equipment that meets the critical specifications given in the table can be substituted for the recommended model(s).

### Accessories You Should Have

Table 3-2 lists a number of accessories used during Operation Verification.

---

## **Recording the Test Results**

A small test results table is provided at the end of each test procedure for your convenience in recording test results as you perform the procedure.

In addition, a complete Operation Verification Test Record form is provided as Table 3-8 at the end of the chapter. We recommend that you make a copy of this table, record the complete test results on the copy, and keep the copy for your calibration test record. This record could prove valuable in tracking gradual changes in test results over long periods of time.

## **If the Analyzer Doesn't Meet Specifications**

If the analyzer doesn't meet one or more of the specifications, complete any remaining Operation Verification tests and record all test results on a copy of the test record. Then refer to Chapter 4, "If Something Goes Wrong . . .," for instructions on how to solve the problem.

## **Periodically Verifying Operation**

The analyzer requires periodic verification of operation. Under most conditions of use, you should test the analyzer at least once a year with either Operation Verification or the Performance Test.

Table 3-1. Recommended Test Equipment

Instrument	Critical Specification	Recommended Model
Synthesizer/ Level Generator	Frequency accuracy: $1 \times 10^{-9}$ /day Output flatness: $\pm 0.5$ dB Frequency range: 200 Hz to 10 MHz	HP 3335A
Synthesized Sweeper	Frequency accuracy: $1 \times 10^{-9}$ /day Output flatness: $\leq 0.6$ dB Frequency range: 10 MHz to 26.5 GHz	HP 8340A*
Power Meter	Measure levels 0 to $-20$ dBm Accuracy $\pm 0.5$ %	HP 436A
Power Sensor	Frequency range: 100 kHz to 2 GHz Power range: 10 $\mu$ W to 1 mW	HP 8482A
Power Splitter	Equivalent output SWR: $\leq 1.10$ (leveling) Frequency range: 10 MHz to 2 GHz Maximum input power: $> -10$ dBm	HP 11667A
Frequency Comb Generator	1, 10, 100 MHz combs Accuracy: $\pm 0.01$ %	HP 8406A
AM/FM Signal Generator	Frequency range: 500 kHz to $> 500$ MHz AM modulation: $> 20$ Hz with external signal Pulse modulation: 500 Hz PRF, $> 2$ $\mu$ s pulse width Output flatness: $\pm 0.5$ dB Spurious: $< -100$ dBc	HP 8640B
50-ohm Load (BNC)	Not critical	HP 11593A

\*Notes: the following alternate models can be used in place of the HP 8340A, as indicated; however, range limitations in their critical specifications may prevent complete testing:

- (1) for Frequency Readout Accuracy Test: HP 8640B AM/FM Signal Generator with Option 002 Doubler; Frequency range: 500 kHz to 1024 MHz
- (2) for Frequency Response Flatness Test: HP 8350A/83522A Sweep Oscillator; Output flatness:  $< \pm 0.6$  dB
- (3) for both tests (1) and (2): HP 8642B Signal Generator; Frequency range: 100 kHz to 2115 MHz



Table 3-2. Recommended Accessories

<b>Accessory</b>	<b>Recommended HP Part Number</b>
50- $\Omega$ Termination (BNC)	11593A
Output Adapters for HP 8340:	
SMA (f) to SMA (f)	1250-1158
SMA (m) to BNC (f)	1250-1200
Adapter for HP 11667A:	
Type N (m) to BNC (f) (2 required)	1250-0780
BNC Cable (2 required)	8120-1839

---

## Frequency Readout Accuracy

This test verifies the analyzer's ability to measure the frequency of a single CW signal. The test requires a synthesized frequency source that has better frequency accuracy than the HP 8590A. Note that two different Hewlett-Packard synthesized sources are recommended to cover the specified frequency range of the analyzer. The following steps summarize the Frequency Readout Accuracy test:

- Inject a 50-MHz CW signal from a synthesized source into the RF INPUT of the analyzer.
- Position the marker on the signal peak.
- Compare the analyzer's marker frequency to the specification.
- Repeat the preceding steps for source frequencies of 100, 500, 1000, and 1500 MHz.

### Specification

$\pm(5 \text{ MHz} + 1\% \text{ of frequency span})$

### Recommended Equipment

Frequency Synthesizer .....	HP 3335A
Synthesized Sweeper .....	HP 8340A
BNC cable .....	HP Part Number 8120-1839
Output adapters for HP 8340:	
SMA (f) to SMA (f) .....	HP Part Number 1250-1158
SMA (m) to BNC (f) .....	HP Part Number 1250-1200

## Test Procedure

1. Connect the 50Ω OUTPUT of the HP 3335A Frequency Synthesizer to the RF INPUT of the HP 8590A Spectrum Analyzer with a BNC cable.
2. Set the frequency synthesizer output to 50 MHz and -10 dBm with no modulation.
3. Press the following spectrum analyzer keys:  
 PRESET (wait until the preset is complete)  
 SPAN 1 0 MHz  
 FREQUENCY 5 0 MHz  
 PEAK SEARCH
4. Record the analyzer's frequency reading in Table 3-3, Frequency Readout Accuracy Test Results, and in Table 3-8, Operation Verification Test Record.
5. Repeat steps 2, 3, and 4 for the frequencies shown in the test record, but use an HP 8340A Synthesized Sweeper instead of the HP 3335A Frequency Synthesizer.

## Test Results

Table 3-3. Frequency Readout Accuracy

Test Description	Results		
	Min.	Actual	Max.
Frequency Readout Accuracy			
50 MHz	44.90 MHz	_____	55.10 MHz
100 MHz	94.90 MHz	_____	105.10 MHz
500 MHz	494.90 MHz	_____	505.10 MHz
1000 MHz	994.90 MHz	_____	1005.10 MHz
1500 MHz	1494.90 MHz	_____	1505.10 MHz
1700 MHz (Option H18)	1694.90 MHz	_____	1705.10 MHz

---

## Displayed Average Noise

This test measures the noise generated by the circuits of the HP 8590A Spectrum Analyzer. This noise, called average noise, affects the analyzer's ability to measure small signals. The lower the average noise level, the greater the sensitivity and dynamic range.

This test uses the marker to measure the displayed noise with no input signal present. Since the noise measured by this test is internal to the analyzer, it is not affected by the input attenuator. However, the input attenuator setting is coupled to the displayed amplitude level. Therefore, the input attenuator must be set to 0 dB to get an accurate amplitude reading of the noise.

The following steps summarize this test:

- Connect a 50- $\Omega$  load to the RF INPUT of the analyzer.
- Set the analyzer to the specified settings and use the marker to measure the noise.

### Specification

Maximum average noise level with 0-dB input attenuation, 1-kHz resolution bandwidth, and 30-Hz video bandwidth:

- < -115 dBm for frequencies >1 MHz to 1.3 GHz
- < -113 dBm for frequencies >300 kHz to 1.5 GHz
- < -95 dBm for frequencies >1.5 GHz to 1.79 GHz (Option H18)
- < -61 dBmV for 75-ohm calibration, for frequencies >1 MHz to 1.3 GHz (Option 001)

### Recommended Equipment

50- $\Omega$  Termination (BNC) ..... HP Part Number 11593A

## Test Procedure

1. Connect the 50- $\Omega$  termination to the RF INPUT of the HP 8590A Spectrum Analyzer.
2. Press the following analyzer keys:  
 [PRESET] (wait until the preset is complete)  
 [SPAN] [0] [Hz]  
 [SWEEP BW] [RES BW] [1] [kHz]  
 [VID BW] [3] [0] [Hz]  
 [AMPLITUDE] [8] [0] [-dBm]  
 [ATTEN] [0] [+dBm]
3. Press the following analyzer keys:  
 [TRIG] [SINGLE SWEEP]  
 [PEAK SEARCH]
4. Read the average noise level as the marker amplitude.
5. Repeat steps 3 and 4 for the analyzer frequencies (1 MHz, 750 MHz, and 1500 MHz) shown in Table 3-4.
6. Record the test results in Table 3-4, Displayed Average Noise, and in Table 3-8, Operation Verification Test Record.

## Test Results

Table 3-4. Displayed Average Noise

Test Description	Results		
	Min.	Actual	Max.
Displayed Average Noise			
300 kHz		_____	-113 dBm
1 MHz		_____	-115 dBm
750 MHz		_____	-115 dBm
1500 MHz		_____	-113 dBm
1700 MHz (Option H18)		_____	- 95 dBm

## Frequency Response Flatness

This test measures the analyzer's ability to accurately compare the amplitudes of two signals of equal amplitude but different frequency (e.g., a two-tone intermodulation measurement). This ability, called flatness, affects the analyzer's ability to accurately compare the amplitudes of two signals of unequal amplitude (e.g., carriers and sidebands).

A synthesized sweeper is used for this test because its flatness is relatively better than the analyzer's. The sweeper sweeps a signal through the band of the analyzer while the analyzer is in [MAX HOLD A]. This procedure traces the flatness of the analyzer on the analyzer's screen. Two different synthesized sweepers are used to cover the entire frequency range of the analyzer.

### Specification (with 10-dB of input attenuation)

- <±1.5 dB referenced to a 300-MHz, -10 dBm signal
- <±3.0 dB referenced to a 300-MHz, -10 dBm signal, 1500 MHz to 1790 MHz (Option H18)
- <±1.0 dB referenced to a midpoint between the highest and lowest amplitude excursions
- <±2.0 dB referenced to a midpoint between the highest and lowest amplitude excursions, 1500 MHz to 1790 MHz (Option H18)

### Recommended Equipment

Frequency Synthesizer .....	HP 3335A
Synthesized Sweeper .....	HP 8340A
Power Meter .....	HP 436A
Power Sensor .....	HP 8482A
Power Splitter .....	HP 11667A
BNC cable (3 required) .....	HP Part Number 8120-1839
Output adapters for HP 8340:	
SMA (f) to SMA (f) .....	HP Part Number 1250-1158
SMA (m) to BNC (f) .....	HP Part Number 1250-1200
Adapters for HP 11667A:	
Type N (m) to BNC (f), (2 required) .....	HP Part Number 1250-0780

### Test Procedure (10 kHz to 10 MHz)

1. Press the following keys on the analyzer:
  - [PRESET] (wait until the preset is complete)
  - [START FREQ] [1] [0] [kHz]
  - [STOP FREQ] [1] [0] [MHz]
  - [AMPLITUDE] [1] [6] [-dBm]
2. Set the HP 3335A Frequency Synthesizer to a CW output of 5 to 7 MHz at -20 dBm. Connect the equipment as shown in Figure 3-1(a).

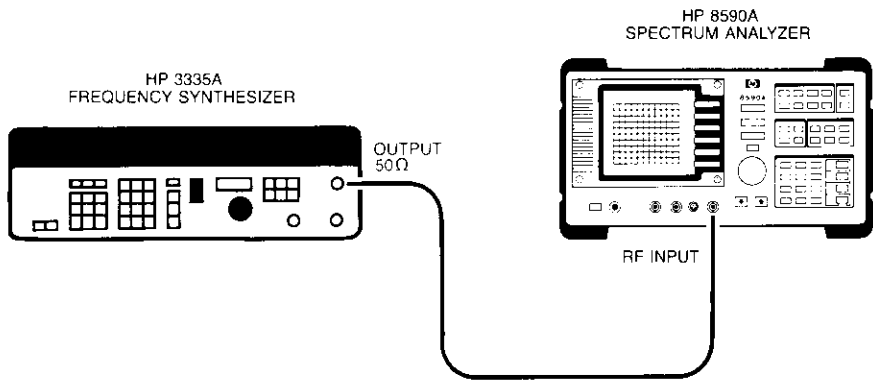

(a) 10 kHz to 10 MHz

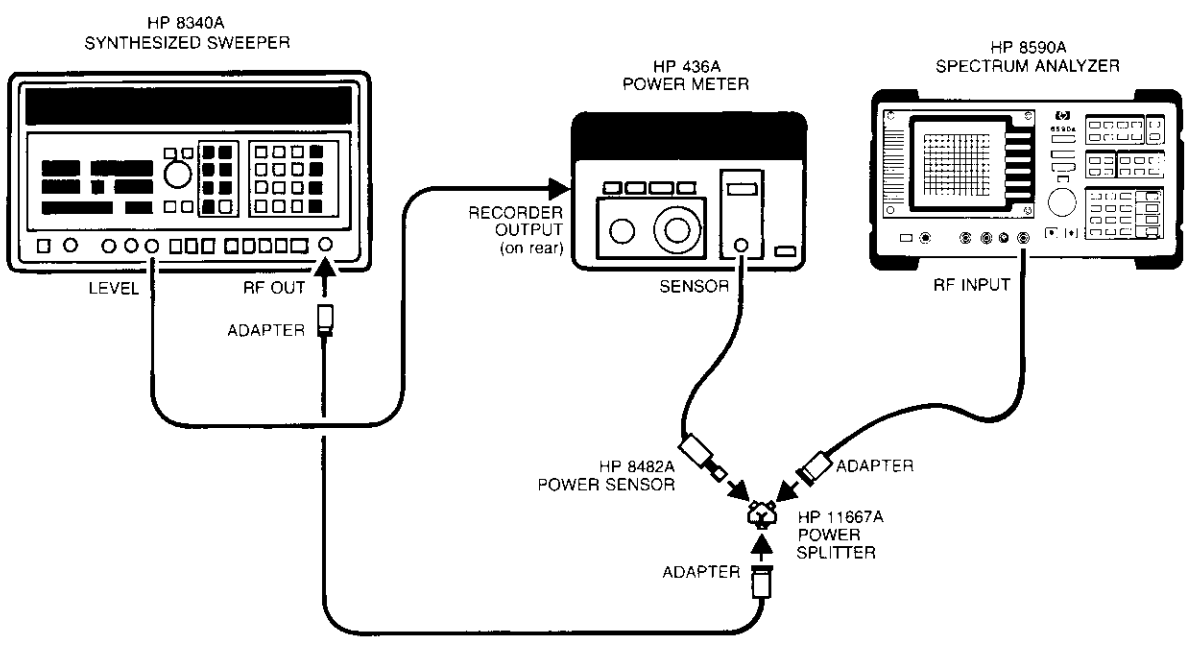

(b) 10 MHz to 1500 MHz

Figure 3-1. Test Setup—Frequency Response Flatness

- 
3. Tune the frequency synthesizer to place the signal at the center of the analyzer's screen. Set the sweep width of the frequency synthesizer to 10 MHz.
  4. Press [LOG dB/DIV] [1] [+dBm] on the analyzer. Adjust the output power of the frequency synthesizer to place the signal at approximately midscreen.
  5. Press GO TO START FREQ on the frequency synthesizer and press [TRACE A] [MAX HOLD A] on the analyzer.
  6. Start a 50-second single sweep in the frequency synthesizer. At the end of the sweep, press [VIEW A] on the analyzer.
  7. The frequency response flatness is the maximum peak-to-peak trace variation on the spectrum analyzer's screen. This variation should be less than 2.0 dB.
  8. Record the test results on copies of Table 3-5, Frequency Response Flatness, and Table 3-8, Operation Verification Test Record.

#### Test Procedure (10 MHz to 1500 MHz) or (10 MHz to 1790 MHz, Option H18)

1. Press the following keys on the analyzer:  
 [PRESET] (wait until the preset is complete)  
 [FREQUENCY]  
 [START FREQ] [1] [0] [MHz]  
 [STOP FREQ] [1] [5] [0] [0] [MHz] or ([1] [7] [9] [0] [MHz] (Option H18)  
 [AMPLITUDE] [1] [6] [-dBm]  
 [LOG dB/DIV] [1] [+dBm]
2. Set the HP 8340A Synthesized Sweeper to CW 300 MHz, then set the power level to -20 dBm.
3. Calibrate the power meter.
4. Connect the recommended equipment as shown in Figure 3-1(b).
5. If necessary, adjust the output power of the synthesized sweeper to position the 300-MHz signal four divisions down from the analyzer's reference level.



6. On the analyzer, press **[TRACE A]** and **[MAX HOLD A]**.
7. Set the synthesized sweeper's start frequency to 10 MHz and the stop frequency to 1500 MHz or 1790 MHz (Option H18).
8. On the synthesized sweeper, press **SINGLE SWEEP** to start and complete one sweep. Repeat until three sweeps have been made on the analyzer.
9. On the analyzer, press **[VIEW A]** to store the display.
10. Press **[MKR]** and **[MARKER NORMAL]**. Adjust the tuning knob to place the marker on the 299.99-MHz calibration peak.
11. Press **[MARKER DELTA]** and adjust the tuning knob to place the marker at the lowest point on the trace.
12. Read the amplitude difference (direct readout displayed in both the active function block and marker readout areas of the screen).
13. Adjust the tuning knob to place the marker at the highest point on the trace.
14. Read the displayed amplitude difference.
15. The frequency response flatness is the maximum peak-to-peak trace variation on the spectrum analyzer's screen. This variation should be less than  $\pm 1.0$  dB, referenced to the 299.9-MHz CAL signal.
16. Record the test results on copies of Table 3-5, Frequency Response Flatness, and Table 3-8, Operation Verification Test Record.

**Test Results**

*Table 3-5. Frequency Response Flatness*

Test Description	Results		
	Min.	Actual	Max.
<b>Frequency Response Flatness</b>			
10 kHz to 10 MHz		_____	2.0 dB
10 MHz to 1500 MHz		_____	1.0 dB
10 MHz to 1790 MHz (Option H18)		_____	2.0 dB

---

## Calibrator Amplitude and Frequency Accuracy

This test measures the accuracy of the analyzer's calibrator signal. The analyzer uses this signal in its calibration routines. Therefore, the calibration of the analyzer depends on the accuracy of this signal.

The calibrator signal is measured directly using a power meter for amplitude accuracy and a frequency counter for frequency accuracy.

### Specification

Amplitude:  $-20 \text{ dB} \pm 1.0 \text{ dB}$  (50-ohm calibration)  
 $+27 \text{ dBmV} \pm 1.0 \text{ dB}$  (75-ohm calibration (Option 001))

Frequency:  $299.9 \text{ MHz} \pm 300 \text{ KHz}$

### Recommended Equipment

Frequency Counter ..... HP 5383A  
Power Meter ..... HP 436A  
Power Sensor ..... HP 8482A  
BNC cable ..... HP Part Number 8120-1839

## Test Procedure

1. Press **PRESET** on the HP 8590A Spectrum Analyzer.
2. Calibrate the power meter and power sensor.
3. Connect the power sensor to the CAL OUTPUT of the analyzer.
4. Record the power reading on a copy of the test record. The power reading should be between the values shown on the test record.
5. Set the frequency counter input impedance to 50Ω and the gate time to MHz.
6. Connect the analyzer's CAL OUTPUT to the input of the frequency counter.
7. Record the frequency reading on the counter on copies of Table 3-6, Calibrator Amplitude and Frequency Accuracy, and Table 3-8, Operation Verification Test Record. The frequency reading should be between the values shown on the tables.

## Test Results

Table 3-6. Calibrator Amplitude and Frequency Accuracy

Test Description	Results		
	Min.	Actual	Max.
<b>Calibrator Amplitude</b> 50 ohms: -20 dBm 75 ohms: +27 dBmV (Option 001)	-21 dBm +26 dBmV	_____	-19 dBm +28 dBmV
<b>Frequency Accuracy</b> 299.9 MHz	299.6 MHz	_____	300.2 MHz

---

## Frequency Span Readout Accuracy

This test measures the analyzer's ability to accurately read the frequency of two signals at the same time. The test uses a frequency comb generator. A comb generator gets its name from the signals it generates. The signals are evenly spaced in the frequency spectrum so that they resemble the teeth of a comb.

The comb generator is used to test the wide spans (20 MHz to 1500 MHz). A signal generator is modulated with a synthesizer to generate comb signals for testing the narrow spans (50 kHz to 1 MHz).

The span readout accuracy test is summarized as follows:

- Set the comb generator frequency so that a comb tooth signal falls on each graticule of the analyzer span under test.
- Place one of the analyzer's markers on the comb signal at the left edge of the screen. Place the other marker on the comb signal at the right edge of the screen.
- Read the span as the marker delta frequency and compare it to the specification.

### Specifications

<±3% of indicated frequency span, 50 kHz to 1500 MHz

### Recommended Equipment

Frequency Comb Generator .....	HP 8406A
AM/FM Signal Generator .....	HP 8640B
Frequency Synthesizer .....	HP 3335A
BNC cable (2 required) .....	HP Part Number 8120-1839
Adapter, Type N (m) to BNC (f) .....	HP Part Number 1250-0780

### Test Procedure (20 to 1500 MHz spans)

1. Set the HP 8406A Comb Generator to 100 MC, with the INTERPOLATION AMPLITUDE 1MHz to off, and the OUTPUT AMPLITUDE control completely counterclockwise.
2. Connect the equipment as shown in Figure 3-2(a).

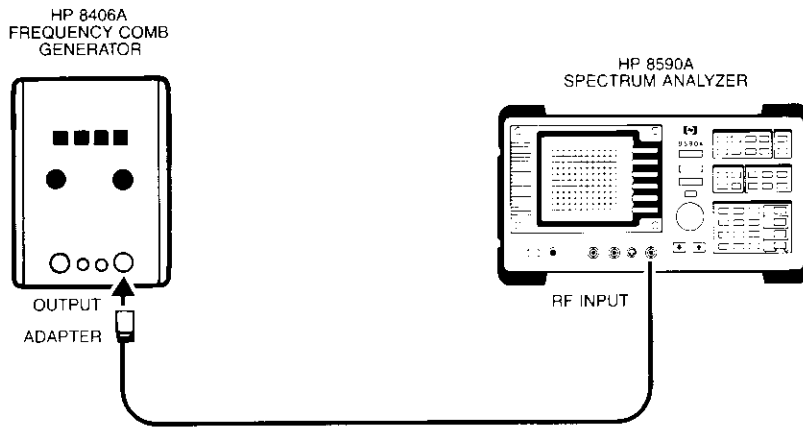

(a) 20- to 1500-MHz Spans

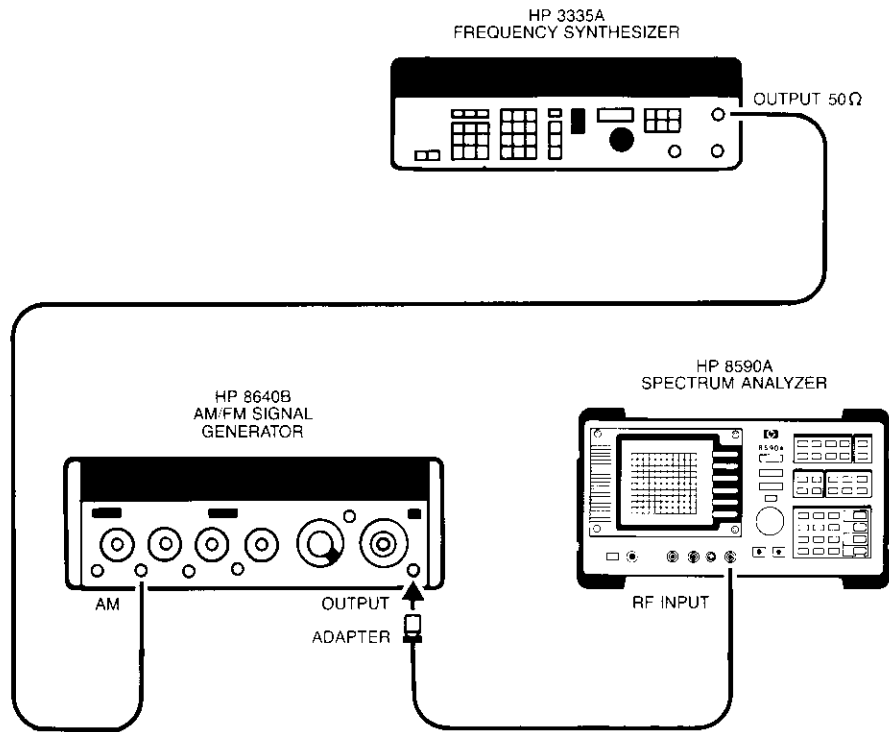

(b) 50-kHz to 1-MHz Spans

Figure 3-2. Test Setup—Frequency Span Readout Accuracy

- 
3. Press the following spectrum analyzer keys:

**PRESET** (wait until the preset is complete)

**FREQUENCY**

Use the knob to place a comb signal at the left edge of the screen.

**MKR** **[MARKER NORMAL]** **2** **0** **0** **MHz**

Use the knob to set the marker on the peak of the second comb signal from the left edge of the screen.

**[MARKER DELTA]** **1** **5** **0** **0** **MHz**

Set the second marker on the peak of the 15th comb signal from the left.

4. Read the span as the marker delta frequency. Record the span on copies of Table 3-7, Frequency Span Readout Accuracy, and Table 3-8, Operation Verification Test Record. The span should fall between the values shown on the tables (1261 MHz and 1339 MHz).
5. Repeat steps 3 and 4 for the frequency spans shown in the test record (1000, 500, 100, and 20 MHz).

**Note:** In the 20-MHz span, set the analyzer attenuator to 0 dBm. And in the 20- and 100-MHz spans, set the comb frequency to 1 MHz and 10 MHz, respectively.

### Test Procedure (50 kHz to 1 MHz spans)

1. Connect the equipment as shown in Figure 3-2(b).
2. Set the HP 8640B Signal Generator for -10 dBm, 10 MHz, and its amplitude modulation input for ac coupling.
3. Set the HP 3335A Frequency Synthesizer to +10 dBm at 100 kHz and adjust the signal generator for 90% amplitude modulation.
4. Press the following analyzer keys:

**PRESET** (wait until the preset is complete)

**FREQUENCY** **1** **0** **MHz**

**SPAN** **1** **MHz**

**PEAK/SEARCH** **[SIGNAL TRACK]** **MKR****[MARKER NORMAL]**

Use the knob to set the marker on the peak of the signal at the left edge of the screen.

**[MARKER DELTA]**

Use the knob to set the second marker on the peak of the signal at the right edge of the screen.

5. Read the span as the marker delta frequency. Record the span on the copies of Tables 3-7 and 3-8. The span should fall between the values shown on the tables (800 kHz  $\pm$ 30 kHz).
6. Repeat step 4 for a span of 500 kHz with the frequency synthesizer set to 100 kHz. Record the span (marker reading) (400 kHz  $\pm$ 15 kHz) on the copies of Tables 3-7 and 3-8.
7. Use the following settings to test the analyzer's 50- and 100-kHz spans. Record the results.

Analyzer Span	HP 3335A Frequency
50 kHz	5 kHz
100 kHz	10 kHz

[TRACE A] [VIEW A] [MKR][MARKER NORMAL]

Use the knob to set the marker on the peak of the signal at the left side of the screen.

[MARKER DELTA]

Use the knob to set the marker on the peak of the signal at the right side of the screen.

## Test Results

Table 3-7. Frequency Span Readout Accuracy

Test Description	Results		
	Min.	Actual	Max.
<b>Frequency Span Readout Accuracy</b>			
50 kHz	38.50 kHz	_____	41.50 kHz
100 kHz	77.00 kHz	_____	83.00 kHz
500 kHz	385.00 kHz	_____	415.00 kHz
1 MHz	770.00 kHz	_____	830.00 kHz
20 MHz	17.40 MHz	_____	18.60 MHz
100 MHz	77.00 MHz	_____	83.00 MHz
500 MHz	385.00 MHz	_____	415.00 MHz
1000 MHz	770.00 MHz	_____	830.00 MHz
1500 MHz	1255.00 MHz	_____	1355.00 MHz

Table 3-8. Operation Verification Test Record

Hewlett-Packard Company		Tested by _____	
HP Model 8590A		Date _____	
Spectrum Analyzer 10 kHz to 1.5 GHz			
Option 001: 1 MHz to 1.5 GHz		Serial No. _____	
Option H18: 10 kHz to 1.79 GHz			
Test Description	Results		
	Min.	Actual	Max.
<b>Frequency Readout Accuracy</b>			
50 MHz	44.90 MHz	_____	55.10 MHz
100 MHz	94.90 MHz	_____	105.10 MHz
500 MHz	494.90 MHz	_____	505.10 MHz
1000 MHz	994.90 MHz	_____	1005.10 MHz
1500 MHz	1494.90 MHz	_____	1505.10 MHz
1700 MHz (Option H18)	1694.90 MHz	_____	1705.10 MHz
<b>Displayed Average Noise</b>			
300 kHz		_____	-113 dBm
1 MHz		_____	-115 dBm
750 MHz		_____	-115 dBm
1500 MHz		_____	-113 dBm
1700 MHz (Option H18)		_____	- 95 dBm
<b>Frequency Response Flatness</b>			
10 kHz to 10 MHz		_____	2.0 dB
10 MHz to 1500 MHz		_____	1.0 dB
1500 MHz to 1790 MHz (Option H18)		_____	2.0 dB
<b>Calibrator Amplitude</b>			
50 ohms: -20 dBm	-21 dBm	_____	-19 dBm
75 ohms: +27 dBmV (Option 001)	+26 dBmV	_____	+28 dBmV
<b>Frequency Accuracy</b>			
299.9 MHz	299.6 MHz	_____	300.2 MHz
<b>Frequency Span Readout Accuracy</b>			
50 kHz	38.50 kHz	_____	41.50 kHz
100 kHz	77.00 kHz	_____	83.00 kHz
500 kHz	385.00 kHz	_____	415.00 kHz
1 MHz	770.00 kHz	_____	830.00 kHz
20 MHz	17.40 MHz	_____	18.60 MHz
100 MHz	77.00 MHz	_____	83.00 MHz
500 MHz	385.00 MHz	_____	415.00 MHz
1000 MHz	770.00 MHz	_____	830.00 MHz
1500 MHz	1255.00 MHz	_____	1355.00 MHz

Verification



---

## IF SOMETHING GOES WRONG . . .

---

### What You'll Find in This Chapter

Your HP 8590A Spectrum Analyzer is built to provide dependable service. It is unlikely that you will experience a problem with the HP 8590A. However, if you do, or if you desire additional information or wish to order parts, options, or accessories, HP's worldwide sales and service organization is ready to provide the support you need.

In general, a problem can be caused by a hardware failure, a software error, or a user error. Follow these general steps to determine the cause and to resolve the problem:

- perform the quick checks listed in the "Check the Basics" paragraph; these checks may eliminate the problem altogether, or may give a clearer idea of its cause
- if the problem is a hardware problem, you have several options:
  - repair it yourself; see the "Service Options" paragraph
  - return the analyzer to HP for repair;
    - if the analyzer is still under warranty or is covered by an HP maintenance contract, it will be repaired under the terms of the warranty or maintenance contract (the warranty is printed on the inside front cover of this manual)
    - if the analyzer is no longer under warranty or covered by an HP maintenance contract, HP will notify you of the cost of the repair after examining the unit

See the "How to Call HP" and "How to Return Your Analyzer for Service" paragraphs for more information.

---

## Before You Call HP

### Check the Basics

A problem often can be solved by rechecking what was being done when the problem occurred. A few minutes spent in performing some simple checks may save waiting for your instrument to be repaired. Before calling HP or returning the analyzer for service, please make the following checks:

- Is the analyzer plugged in to the proper ac power source? Does the line socket have power?
- Is the rear-panel voltage selector switch set correctly? Is the line fuse good?
- Is the analyzer turned on?
- If other equipment, cables, and connectors are being used with the HP 8590A, are they connected properly and operating correctly?
- Review the procedure for the test being performed when the problem appeared. Are all the switch settings correct?
- Is the test being performed, and the results that are expected, within the specifications and capabilities of the HP 8590A? (See Chapter 1, Table 1-1, for analyzer specifications.)
- Is the HP 8590A displaying an error message? If so, refer to Appendix A.
- Are the analyzer's measurements obviously inaccurate? If so, the analyzer's calibration data may have been destroyed. Refer to the HP 8590A Support Manual or contact the nearest Hewlett-Packard Sales and Service Office listed in Table 4-1.
- Perform the frequency and amplitude calibration routines given in the "Turning the HP 8590A On for the First Time" paragraph in Chapter 2. After running these routines, perform the Confidence Test that is described in the same paragraph. Record all error messages that appear.
- If the necessary test equipment is available, perform the Operation Verification tests given in Chapter 3. Record all results on an Operation Verification Test Record form (Table 3-8).

---

## Read the Warranty

The warranty for your HP 8590A is printed on the inside front cover of this manual. Please read it and become familiar with its terms.

If your analyzer is covered by a separate maintenance contract, please be familiar with its terms.

## Service Options

HP offers several maintenance services for your analyzer after the warranty has expired. Call your HP Sales and Service office for full details.

If you want to service the analyzer yourself after the warranty expires, you can purchase a Service Documentation Package that provides all necessary test and maintenance information. You can order the Service Documentation Package, HP Part Number 08590-90007, through your HP Sales and Service office. The package is described under "Service Documentation (Option 915)" in Chapter 1 of this manual.

## How to Call HP

Hewlett-Packard has Sales and Support offices around the world to provide you with complete support for your HP 8590A. To obtain servicing information or to order replacement parts, contact the nearest Hewlett-Packard Sales and Service Office listed in Table 4-1. In any correspondence or telephone conversations, refer to the instrument by its model number and full serial number. With this information, the HP representative can quickly determine whether your unit is still within its warranty period.

Table 4-1. HP Spectrum Analyzer Service Offices

<p><b>IN THE UNITED STATES</b></p> <p><b>California</b>  Hewlett-Packard Co.  P.O. Box 4230  1421 South Manhattan Ave.  Fullerton, CA 92631  (714) 999-6700</p> <p>Hewlett-Packard Co.  333 Logue Ave.  Mountain View, CA 94040  (415) 969-0880</p> <p><b>Colorado</b>  Hewlett-Packard Co.  24 Inverness Place, East  Englewood, CO 80112  (303) 649-5000</p> <p><b>Georgia</b>  Hewlett-Packard Co.  P.O. Box 105005  2000 South Park Place  Atlanta, GA 30339  (404) 955-1500</p> <p><b>Illinois</b>  Hewlett-Packard Co.  5201 Tollview Drive  Rolling Meadows, IL 60008  (312) 255-9800</p> <p><b>New Jersey</b>  Hewlett-Packard Co.  120 W. Century Road  Paramus, NJ 07653  (201) 265-5000</p> <p><b>Texas</b>  Hewlett-Packard Co.  930 E. Campbell Rd.  Richardson, TX 75081  (214) 231-6101</p>	<p><b>IN AUSTRALIA</b>  Hewlett-Packard Australia Ltd.  31-41 Joseph Street  Blackburn, Victoria 3130  895-2895</p> <p><b>IN CANADA</b>  Hewlett-Packard (Canada) Ltd.  17500 South Service Road  Trans-Canada Highway  Kirkland, Quebec H9J 2X8  (514) 697-4232</p> <p><b>IN FRANCE</b>  Hewlett-Packard France  F-91947 Les Ulis Cedex  Orsay  (6) 907-78-25</p> <p><b>IN GERMAN FEDERAL REPUBLIC</b>  Hewlett-Packard GmbH  Vertriebszentrale Frankfurt  Berner Strasse 117  Postfach 560 140  D-6000 Frankfurt 56  (0611) 50-04-1</p> <p><b>IN GREAT BRITAIN</b>  Hewlett-Packard Ltd.  King Street Lane  Winnersh, Wokingham  Berkshire RG11 5AR  0734 784774</p> <p><b>IN OTHER EUROPEAN COUNTRIES</b>  Hewlett-Packard (Schweiz) AG  Allmend 2  CH-8967 Widen (Zurich)  (0041) 57 31 21 11</p>
--	---

Table 4-1. HP Spectrum Analyzer Service Offices (continued)

<p><b>IN JAPAN</b> Yokogawa-Hewlett-Packard Ltd. 29-21 Takaido-Higashi, 3 Chome Suginami-ku Tokyo 168 (03) 331-6111</p> <p><b>IN PEOPLE'S REPUBLIC OF CHINA</b> China Hewlett-Packard, Ltd. P.O. Box 9610, Beijing 4th Floor, 2nd Watch Factory Main Bldg. Shuang Yu Shu, Bei San Huan Rd. Beijing 28-0567</p>	<p><b>IN SINGAPORE</b> Hewlett-Packard Singapore Pte. Ltd. #08-00 Inchcape House 450-2 Alexandra Road Alexandra P.O. Box 58 Singapore, 9115 4731788</p> <p><b>IN TAIWAN</b> Hewlett-Packard Taiwan 8th Floor, Hewlett-Packard Building 337 Fu Hsing North Road Taipei (02) 712-0404</p> <p><b>IN ALL OTHER LOCATIONS</b> Hewlett-Packard Inter-Americas 3200 Hillview Avenue Palo Alto, California 94304</p>
--	--

---

## How to Return Your Analyzer for Service

### Service Tag

If you are returning the analyzer to Hewlett-Packard for servicing, fill in and attach a blue service tag. Several service tags are supplied at the rear of this manual.

Please be as specific as possible about the nature of the problem. If you have recorded any error messages that appeared on the screen, or have completed a Performance Test Record, or have any other specific data on the performance of the analyzer, please send a copy of this information with the unit.

### Original Packaging

Before shipping, pack the unit in the original factory packaging materials if they are available. If the original materials were not retained, identical packaging materials are available through any Hewlett-Packard office. Descriptions of the packaging materials are listed in the legend for Figure 2-1.

---

## Other Packaging

### CAUTION

Analyzer damage can result from using packaging materials other than those specified. Never use styrene pellets in any shape as packaging materials. They do not adequately cushion the equipment or prevent it from shifting in the carton. They cause equipment damage by generating static electricity and by lodging in the analyzer fan.

You can repackage the instrument with commercially available materials, as follows:

1. Attach a completed service tag to the instrument.
2. If you have a front-panel cover, install it on the instrument: if not, protect the control panel with cardboard.
3. Wrap the instrument in anti-static plastic to reduce the possibility of damage caused by electrostatic discharge.
4. Use a strong shipping container. A double-walled, corrugated cardboard carton with 159-kg (350-lb) bursting strength is adequate. The carton must be both large enough and strong enough to accommodate the analyzer. Allow at least three to four inches on all sides of the analyzer for packing material.
5. Surround the equipment with three to four inches of packing material and prevent the equipment from moving in the carton. If packing foam is not available, the best alternative is S.D.-240 Air Cap™ from Sealed Air Corporation (Commerce, California, 90001). Air Cap looks like a plastic sheet filled with 1-1/4 inch air bubbles. Use the pink-colored Air Cap to reduce static electricity. Wrapping the equipment several times in this material should both protect the equipment and prevent it from moving in the carton.
6. Seal the shipping container securely with strong nylon adhesive tape.
7. Mark the shipping container "FRAGILE, HANDLE WITH CARE" to assure careful handling.
8. Retain copies of all shipping papers.





---

# APPENDIX A

---

## HP 8590A Messages

The HP 8590A can generate various messages that appear on its screen during operation to provide an indication of progress through a procedure or to indicate a problem.

There are three types of messages: hardware error messages (H), user-created error messages (U), and informational messages (M).

- Hardware error messages indicate the HP 8590A hardware is probably broken.
- User-created error messages appear when the analyzer is used incorrectly. They are usually generated during remote operation.
- Informational messages indicate analyzer progress within a specific procedure.

The messages are listed in alphabetical order on the following pages; each message is defined, and its type is indicated by an (H), (U), or (M). In several instances, you are referred to the command description (for example, "See AUNITS.") These command descriptions are contained in the HP-IB, HP-IL, and RS-232 Programming Manuals.

---

ADC-GND FAIL

Indicates a failure in the analog-to-digital converter. (H)

ADC-TIME FAIL

Indicates a failure in the analog-to-digital converter. (H)

ADC-2v FAIL

Indicates a failure in the analog-to-digital converter. (H)

CAL: FM SPAN SENS FAIL

The analyzer could not set up span sensitivity of the FM coil. (H)

CAL: LINEAR DET FAIL

The linear calibration routine failed. (H)

CAL: RES BW AMPL FAIL

The relative insertion loss of the resolution bandwidth is incorrect. (H)

CAL: SPAN SENS FAIL

The calibration span sensitivity routine failed. (H)

CAL: \_\_\_

During the calibration routine, messages may appear on the display indicating the routine is progressing:

MC DELAY, FM DELAY, DONE, SWEEP, SWP DELAY, FREQ, SPAN, AMPTD,  
3dB BW, ATTEN, LOG AMP. (M)

COMMAND ERROR: \_\_\_

The specified command is not recognized by the analyzer. (U)

CONFLICT TABLE OVERFLOW

A command has been used that is not compatible with the HP 8590A. (U)

FAIL: \_\_\_

An error was discovered during the power-up check. The 4-digit by 8-digit code indicates the type of error. (H)

INVALID AUNITS: \_\_\_

The amplitude units are not valid. See AUNITS. (U)

INVALID BLOCK FORMAT: IF STATEMENT

An invalid block format appeared within the IF statement. (U)

INVALID CHECKSUM: USTATE

The user-defined state does not follow the expected format. (U)

---

INVALID COMPARE OPERATOR

An IF/THEN or DO/UNTIL routine is improperly constructed. (U)

INVALID DETECTOR: \_\_\_

The specified detector is not valid. See DET. (U)

INVALID ENTER FORMAT

The enter format is not valid. See the appropriate command description to determine the correct format. (U)

INVALID HP-IB ADDRESS OR OPERATION

An HP-IB operation was aborted due to an incorrect address or invalid operation. (U)

INVALID HP-IB OPERATION REN TRUE

The HP-IB operation is not allowed. (Usually caused by print/plot when a calculator is on the interface bus.) (U)

INVALID HP-IL ADDRESS OR OPERATION

An HP-IL operation was aborted due to an incorrect address or invalid operation. (U)

INVALID HP-IL OPERATION REN TRUE

The HP-IL operation is not allowed. (Usually caused by print/plot when a calculator is on the interface bus.) (U)

INVALID KEYNAME: \_\_\_

The specified keyname is not allowed. (The keyname may conflict with an analyzer command.) (U)

INVALID OUTPUT FORMAT

The output format is not valid. See the appropriate command description to determine the correct format. (U)

INVALID REPEAT MEM OVFL

Memory overflow occurred due to REPEAT routine. (U)

INVALID REPEAT NEST LEVEL

The nesting level in the REPEAT routine is improperly constructed. (U)

INVALID RS-232 ADDRESS OR OPERATION

An RS-232 operation was aborted due to an incorrect address or invalid operation. (U)

INVALID SAVE REG

Data has not been saved in the specified state register. (U)

---

INVALID SYMTAB: EEROM OVERFLOW

The operator has cataloged too much data. (U)

INVALID SYMTAB: SYMTAB OVERFLOW

There is a symbol table overflow. (U)

INVALID TRACE: \_\_\_

The specified trace is invalid. See trace commands (VIEW, MXMH, CLRW, or BLANK). (U)

INVALID TRACE NAME: \_\_\_

The specified trace name is not allowed. (U)

INVALID TRIGGER MODE: \_\_\_

The specified trigger mode is invalid. See TM. (U)

INVALID VARDEF: \_\_\_

The specified variable name is not allowed. (U)

INVALID WINDOW TYPE: \_\_\_

The specified window is invalid. See TWINDOW. (U)

MEAS UNCAL

The measurement is uncalibrated. Check the sweep time, span, and bandwidth settings. (U)

PARAMETER ERROR: \_\_\_

The specified parameter is not recognized by the analyzer. See the appropriate command description to determine the correct parameters. (U)

SRQ \_\_\_

The specified service request is active. Service requests are a form of informational message and are explained in Appendix B. (M)

SOFTKEY OVFL

Softkey nesting exceeds the maximum number of levels. (U)

UNDEF KEY

A referenced softkey is not recognized by the analyzer. (U)

---

# APPENDIX B

---

## Service Requests

This appendix describes the analyzer service request (SRQ) capability. A service request is an analyzer output that tells the operator or computer that a specific event has taken place in the analyzer.

When writing programs, service requests can be used to interrupt the computer program sequence, causing the program to branch to a subroutine. For example, by using service requests, the computer can perform other operations while the analyzer is sweeping. When the sweep is completed, the computer can service the analyzer by changing the analyzer state or reading data from the display memory.

**Note:** Service requests do not work with computers that have only an RS-232 interface. HP-IB and HP-IL computers do not all have the same service request capabilities. Refer to the manuals supplied by your computer's manufacturer.

When making a service request, the analyzer places the I/O interface SRQ line true and the analyzer CRT display reads out SRQ with a number. Setting the SRQ line true announces to the computer that the analyzer requires attention. The computer can then command the analyzer to send its "status byte". The status byte indicates the type of service request.

**Note:** If the CRT display annotation has been blanked, the service request notation will not appear.

**Note:** A serial polling technique must be used by the computer to test for service requests. The analyzer does not respond to parallel polling.

## Status Byte Definition

The status byte sent by the analyzer determines the nature of the service request. The meaning of each bit of the status byte is explained in Table B-1.

Table B-1. Status Byte Definition

Bit	Message	CRT Display Message
0 (LSB)	Unused	—
1	Unit Key	SRQ 102
2	End of sweep	SRQ 104
3	Hardware broken	SRQ 110
4	Command complete	SRQ 120
5	Illegal analyzer command	SRQ 140
6	Universal HP-IB service request HP-IB RQS bit	—
7	Unused	—

The CRT display message is an octal number based on the binary value of the status byte. This octal number always begins with a "1" since this is translated from bit 6, the universal service request bit. The status byte for an illegal analyzer command (SRQ 140) is as follows:

bit number	7	6	5	4	3	2	1	0
status byte	0	1	1	0	0	0	0	0

The CRT displays the octal equivalent of the status byte binary number:

SRQ 140

The octal equivalent is based on the whole binary number:

01100000 (binary) = 140 (octal)

One simple way to determine the octal equivalent of the binary number is to partition the binary number three bits at a time from the least significant bit, and treat each part as a single binary number:

binary	0	1	1	0	0	0	0	0
octal	1	4						0

---

The decimal equivalent of the octal number is determined as follows:

$$140 \text{ (octal)} = 1 * (8) + 4 * (8) + 0 * (8) = 96 \text{ (decimal)}$$

More than one service request can be sent at the same time. For example, if an illegal analyzer command (SRQ 140) and the end of a sweep (SRQ 104) occurred at the same time, SRQ 144 appears on the CRT display, because both bit 5 and bit 2 are set as shown below:

bit number	7	6	5	4	3	2	1	0	
status byte	0	1	1	0	0	1	0	0	= "SRQ 144"
octal value		1	4			4			

### Service Request Activating Commands

With the exceptions of SRQ 140 and SRQ 102, service requests can only be activated from a computer. (SRQ 140 and SRQ 102 are always activated.) Your HP 8590A Programming Manual describes service request activating commands in Chapter 4 under RQS and SRQ.





---

## Index

75-Ohm Input Impedance (Option 001) .....	1-1
Accessories .....	1-3, 3-2
50-Ohm/75-Ohm Minimum-Loss Pad .....	1-4
75-Ohm Matching Transformer .....	1-4
AC Probe .....	1-3
Broadband Preamplifier .....	1-3
Close Field Probe .....	1-3
Computer .....	1-3
Monitor .....	1-3
Plotter .....	1-3
Printer .....	1-4
Rack Slide Kit .....	1-4
RF Limiter .....	1-4
Tracking Generator .....	1-4
Transit Case .....	1-4
AC Power	
Cables .....	2-6
Fuse .....	2-5
Requirements .....	2-3
Voltage Selector Switch .....	2-4
AC Probe .....	1-3
Amplitude Calibration Routine .....	2-8
Analyzers Covered By This Manual .....	1-5
Before You Call HP .....	4-2
Before You Start Operation Verification .....	3-2
Cable, AC Power .....	2-6
Calibration Routines	
Amplitude .....	2-8
Frequency .....	2-8
Calibrator Amplitude and Frequency Accuracy Test .....	3-14
Case, Transit .....	1-4
Characteristics .....	1-11
Check the Basics .....	4-2
Checking the Fuse .....	2-5
Confidence Test .....	2-9
Displayed Average Noise Test .....	3-8

---

Electrostatic Discharge .....	9
Equipment Rack .....	2-3
Error Messages .....	A-1
Extended Frequency (Option H18) .....	1-2
Frequency Calibration Routine .....	2-8
Frequency Readout Accuracy Test .....	3-6
Frequency Response Flatness Test .....	3-10
Frequency Span Readout Accuracy Test .....	3-16
Front-Panel Cover (Option 040) .....	1-2
Fuse .....	2-5
Getting Ready .....	2-1
How to Call HP .....	4-3
How to Return Your Analyzer for Service .....	4-6
How to Use This Manual .....	3
HP-IB (Option 021) .....	1-2
HP-IL (Option 022) .....	1-2
H18 Option .....	1-2
If the Analyzer Doesn't Meet Specifications .....	3-3
Initial Inspection .....	2-1
Inspection, Initial .....	2-1
Introducing the HP 8590A .....	1-1
Kit, Rack Slide .....	1-4
Limiters, RF .....	1-4
Line Voltage Selector Switch .....	2-4
Messages .....	A-1
Operating and Installation Manuals (Option 910) .....	1-2
Operation Verification .....	3-1
Operation Verification Test Record .....	3-20
Options .....	1-1
1.79-GHz Extended Frequency (Option H18) .....	1-2
75-Ohm Input Impedance (Option 001): .....	1-1
Front-Panel Cover (Option 040): .....	1-2
HP-IB (Option 021): .....	1-2
HP-IL (Option 022): .....	1-2
Operating and Installation Manuals (Option 910): .....	1-2
Rack Mount Flange Kit (Option 908): .....	1-2
Rack Mount Flange Kit With Handles (Option 909): .....	1-2
RS-232 (Option 023): .....	1-2
Service .....	4-3
Service Documentation (Option 915): .....	1-2

---

Options and Accessories Available .....	1-1
Original Packaging .....	2-1, 4-6
Other Packaging .....	4-7
Packaging	
Original .....	2-1, 4-6
Other .....	4-7
Periodically Verifying Operation .....	3-3
Power Cable .....	2-6
Power Requirements .....	2-3
Preamplifier, Broadband .....	1-3
Preparing the HP 8590A for Use .....	2-3
Probe	
AC .....	1-3
Close Field .....	1-3
Procedures	
Amplitude Calibration Routine .....	2-8
Checking the Fuse .....	2-5
Confidence Test .....	2-9
Frequency Calibration Routine .....	2-8
Operation Verification	
Before Starting .....	3-2
Calibrator Amplitude and Frequency Accuracy .....	3-14
Displayed Average Noise .....	3-8
Frequency Readout Accuracy .....	3-6
Frequency Response Flatness .....	3-10
Frequency Span Readout Accuracy .....	3-16
Returning the Analyzer for Service .....	4-6
Setting the Line Voltage Selector Switch .....	2-4
Turning the Analyzer On for the First Time .....	2-8
Rack, Equipment .....	2-3
Rack Mount Flange Kit (Option 908) .....	1-2
Rack Mount Flange Kit with Handles (Option 909) .....	1-2
Recording the Test Results .....	3-2
Routine	
Amplitude Calibration .....	2-8
Frequency Calibration .....	2-8
RS-232 (Option 023) .....	1-2

---

SRQ (service request) .....	B-1
Safety	
Electrostatic Discharge .....	9
General Considerations .....	8
Static-Safe Accessories .....	10
Symbols .....	7
Serial Numbers .....	1-5
Service	
Documentation (Option 915) .....	1-2
How to Return Your Analyzer .....	4-6
Offices .....	4-4
Options .....	4-3
Service Requests (SRQ) .....	B-1
Service Request Activating Commands .....	B-3
Service Tag .....	4-6
Setting the Line Voltage Selector Switch .....	2-4
Specification .....	1-6
Static-Safe Accessories .....	10
Status Byte Definition .....	B-2
Switch, Line Voltage Selector .....	2-4
Symbols, Safety .....	7
System II Cabinet .....	2-3
Test	
Calibrator Amplitude and Frequency Accuracy .....	3-14
Confidence .....	2-9
Displayed Average Noise .....	3-8
Frequency Readout Accuracy .....	3-6
Frequency Response Flatness .....	3-10
Frequency Span Readout Accuracy .....	3-16
Test Equipment You'll Need .....	3-2
Test Record, Operation Verification .....	3-20
Test Results, Recording .....	3-2
Turning the HP 8590A On for the First Time .....	2-8
Voltage Selector Switch .....	2-4
Warranty .....	Inside Cover